

Nikon

Autofocus Speedlight

SB-800DX

SB-800DX (En)

Instruction Manual

CE

En

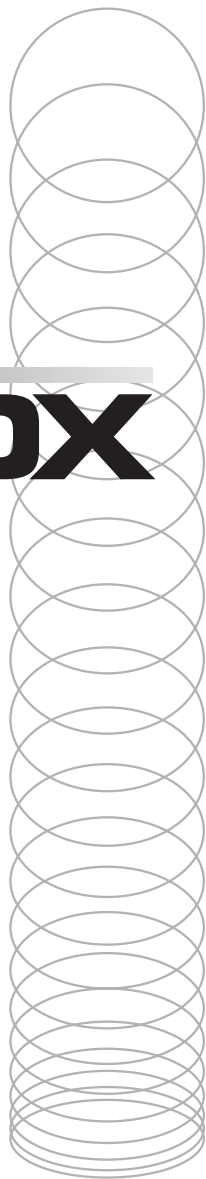

Thank you for purchasing the Nikon Speedlight SB-80DX.
To get the most out of your Speedlight, please read this instruction manual thoroughly before use.

- (p. xx) indicates the reference page.

Main features and functions of the SB-80DX

- The SB-80DX is a high-performance Speedlight having a guide number of 38/125 (at the 35mm zoom-head position, ISO 100, m/ft., 20°C/68°F). According to the camera/lens combination used with the SB-80DX, you can perform various types of TTL auto flash (p. 35), Non-TTL auto flash (p. 40), and Manual flash (p. 44). When used with Nikon Digital SLRs cameras, D-TTL auto flash (p. 35) and AA (Auto Aperture) flash (p. 42) can be performed.
- Automatic power zoom changes the zoom-head position continuously to match the lens focal length (incompatible with some cameras and lenses, see p. 24). The built-in wide-flash adapter increases the angle of coverage to match a 14mm/17mm lens (p. 25).
- Flash head tilts up to 90° or down to -7°, and rotates horizontally 180° to the left and 90° to the right, enabling bounce flash (p. 66) or close-up photography (p. 70).
- Use of the provided Nikon Diffusion Dome in combination with the built-in wide-flash adapter (p. 69) in bounce flash (p.66) or close-up photography (p.70) diffuses the light from the flash to soften shadows and creates well-balanced, more natural-looking pictures.
- Wireless multiple flash photography (p. 82) is also possible.
- For operation in dim light, an illuminator for the LCD panel is provided (p. 10).
- Custom settings are provided to set values, or activate or cancel functions that are not necessary to set each time (p. 12).

Note

- *The Nikon N90s, N90, N70, N60, N55, N50, N8008, N8008s, PRONEA 6i, N6006, N6000, N5005, N4004, and N4004s are sold exclusively in the U.S.A.*
- *The Nikon N80-Series, N65-Series are sold exclusively in the U.S.A. and Central and South America.*
- *The Nikon N2020 and N2000 are sold exclusively in the U.S.A and Canada.*

Tips on using the Speedlight

Take trial shots

Take trial shots before shooting at important occasions like weddings or graduations.

Have Nikon spot-check your Speedlight regularly

Nikon recommends that you have your Speedlight serviced by an authorized dealer or service center at least once every two years.

Using your Speedlight correctly

The Nikon Speedlight SB-80DX's performance has been optimized for use with Nikon brand cameras/accessories including lenses.

Camera/accessories made by other manufacturers may not meet Nikon's criteria for specifications, and nonconforming cameras/accessories could damage the SB-80DX's components. Nikon cannot guarantee the SB-80DX's performance when used with non-Nikon products.

Supplied accessories



Nikon Diffusion Dome
SW-10H (p. 69)

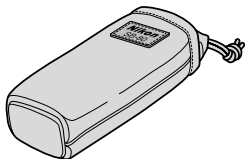

Soft Case SS-80

Camera groups and available flash modes

In this manual, Nikon SLR cameras are divided into eight groups (I to VII, and Digital SLRs) unless otherwise noted. First consult the camera group table to see which group your camera belongs to. Then as you read the manual, you will find specific information on how to use the SB-80DX with your particular camera.

Group	Camera name	TTL auto flash (p. 35)				
		3D Multi-Sensor Balanced Fill-Flash	Multi-Sensor Balanced Fill-Flash	Matrix Balanced Fill-Flash	Center-Weighted Fill-Flash/Spot Fill-Flash	Standard TTL flash
I	F5, F100, F90X/ N90s, F90-Series/ N90, F80-Series/ N80-Series, F70-Series/ N70	○	○	–	○	○
II	F4-Series, F65-Series/N65-Series, F-801s/ N8008s, F-801/N8008, Pronea 600i/6i	–	–	○	○*1	○
III	F-601/N6006, F-601M/N6000	–	–	○	○	○
IV	F60-Series/N60, F50-Series/N50, F-401x/N5005	–	–	○	○	–
V	F-501/N2020, F-401s/N4004s, F-401/N4004, F-301/N2000	–	–	–	○*2	○
VI	FM3A, FA, FE2, FG, Nikonos V, F3-Series (with the AS-17)	–	–	–	–	○
VII	New FM2, FM10, FE10, F3-Series, F55/N55	–	–	–	–	–
Digital SLRs	D1-Series, D100	–	–	–	–	–

*1 Center-Weighted Fill-Flash/Spot Fill-Flash is not possible with the Pronea 600i/6i.

*2 Programmed TTL Auto Flash is set.

*3 TTL auto flash mode for Nikon Digital SLRs.

*4 Possible only when a non-CPU lens is attached.

*5 Repeating Flash is not possible with the F3-Series (using the AS-17).

*6 FP High-Speed Flash sync is not possible with F80-Series/N80-Series and F70-Series/N70 cameras.

D-TTL auto flash ^{*3} (p. 35)				Non-TTL Auto Flash (p. 40)	Auto Aperture Flash (p. 42)	Manual mode			Group
3D Multi-Sensor Balanced Fill-Flash for Digital SLRs	Multi-Sensor Balanced Fill-Flash for Digital SLRs	Center-Weighted Fill-Flash for Digital SLRs	Standard TTL flash for Digital SLRs			Manual Flash (p. 46)	Repeating Flash (p. 48)	FP High-Speed Flash sync (p. 51)	
-	-	-	-	○	-	○	○	○ ^{*6}	I
-	-	-	-	○	-	○	○	-	II
-	-	-	-	○	-	○	○	-	III
-	-	-	-	○	-	○	○	-	IV
-	-	-	-	○	-	○	○	-	V
-	-	-	-	○	-	○	○ ^{*5}	-	VI
-	-	-	-	○	-	○	○	-	VII
○	○	○	○	○ ^{*4}	○	○	○	○	Digital SLRs

The SB-80DX's available flash modes vary, depending on the cameras and lenses in use or the camera's exposure mode and metering system. Refer to "Detailed operation" (p. 33) and your camera's instruction manual.

○ : Available
 - : Not available

Preparation

Foreword.....	2
Tips on using the Speedlight	3
Camera groups and available flash modes	4
Speedlight parts.....	8
LCD panel.....	10
Control buttons	11
Custom settings.....	12
Lenses	14

Basic operation

1 Installing batteries.....	16
2 Test firing.....	18
3 Attach the SB-80DX to the camera and adjust the flash head.	20
4 Setting the ISO sensitivity.....	22
5 Adjusting the zoom-head position	24
6 Setting the camera's exposure mode and metering system	26
7 Setting the SB-80DX's flash mode	28
8 Compose the picture and shoot with flash	30
Using the SB-80DX with the COOLPIX	32

Detailed operation

SB-80DX available flash modes	34
TTL/D-TTL auto flash mode.....	35
Usable cameras compatible with the TTL/D-TTL auto flash mode	36
Non-TTL auto flash mode	40
Auto Aperture flash mode	42
Manual mode.....	44
Notes on continuous flash shooting.....	53
Checking the correct exposure before shooting	54

Advanced operation

Exposure compensation and flash output level compensation.....	56
The flash shooting distance range with zoom lenses having a variable aperture	59
Slow-sync flash mode/Red-eye reduction control.....	60
Rear-curtain sync and Modeling illumination	61
Autofocus flash operation in dim light.....	62

Technical operation/ Effective Speedlight placement

Bounce flash operation	66
Close-up flash operation.....	70
Multiple flash operation.....	74
Multiple flash shooting using cords.....	76
System chart for TTL multiple flash	80
Wireless multiple flash shooting	82

Reference information

Optional accessories	92
Tips on Speedlight care.....	95
Notes on batteries.....	96
Troubleshooting.....	97
Specifications.....	100
Index.....	104

Preparation

This section provides preliminary information on using the SB-80DX.

Basic operation

Basic procedures to take simple, well-balanced flash photographs in the TTL/D-TTL auto flash mode.

Detailed operation

A variety of flash modes available with the SB-80DX are provided.

Advanced operation

Advanced information on each function of the SB-80DX is provided.

Technical operation/Effective Speedlight placement

Bounce, close-up, multiple flash, and their recommended positions are described.

Reference information

Troubleshooting, Speedlight care, etc. are described in this section.

Speedlight parts

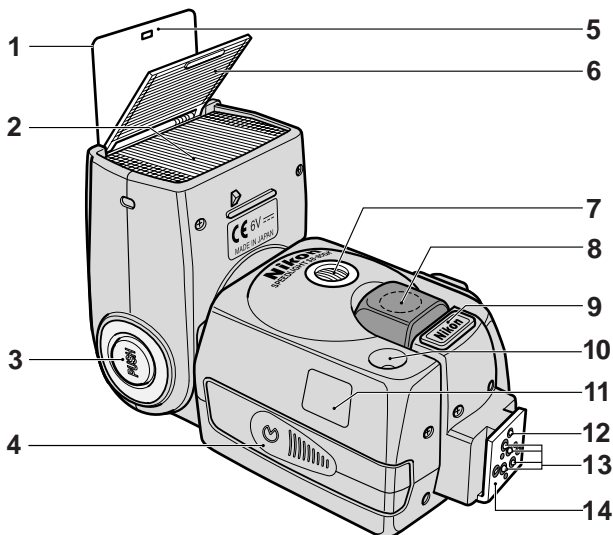

1 Control button quick reference (p. 12)

Easy reference chart for two-button operations and custom settings

2 Flash head (p. 68)

Can be tilted up to 90° or down to -7°, and rotated horizontally 180° to the left and 90° to the right.

3 Flash head tilting/rotating lock release button (p. 20)

4 Battery chamber lid (p. 16)

5 Built-in bounce card (p. 69)

Creates a highlight in the subject's eyes in bounce flash photography.

6 Built-in wide-flash adapter (p. 72)

Increases the angle of coverage to match a 14mm or 17mm lens.

7 Red-eye reduction lamp (p. 60)

Lights up to prevent red-eye from occurring.

8 AF-assist illuminator (p. 62)

Automatically turns on for autofocus operation when the light is dim.

9 External power source terminal (p. 94)

Allows connection of a power cord to the SB-80DX's external power source terminal (supplied with a cover).

10 Light sensor window for Non-TTL auto flash (p. 40)

Senses reflected light from the subject in Non-TTL auto or Auto Aperture flash mode.

11 Light sensor window for wireless slave flash (p. 82)

Senses light from the master flash unit in wireless multiple flash operation.

12 Mount pin

For cameras featuring a safety lock system.

13 Hot-shoe contacts

14 Mounting foot

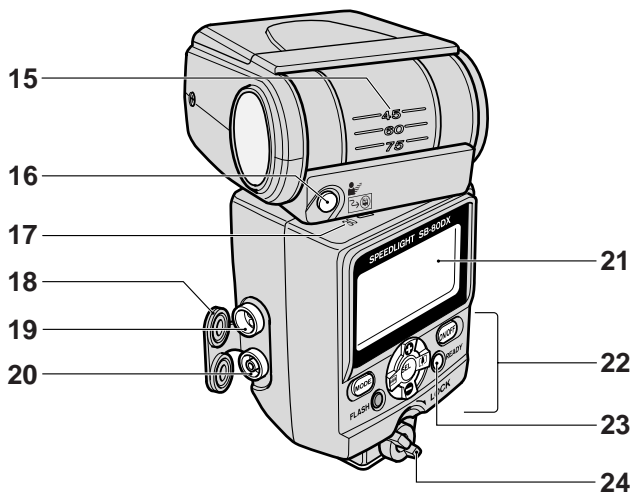

15 Flash head tilting angle scale (p. 68)

16 Modeling illuminator button (p. 61)

Press to fire flash repeatedly to check the illumination and the shadows cast on the subject before taking pictures.

Wireless slave flash cancel button (p. 85)

The SB-80DX will not fire, while this button is pressed.

17 Flash head rotating angle scale (p. 68)

18 Terminal cover

19 TTL multiple flash terminal (p. 78)

Connects the SB-80DX to the slave flash unit(s) in TTL multiple flash operation.

20 Sync terminal (p. 79)

Connects the SB-80DX to the sync terminal of the slave flash unit(s) in other than TTL multiple flash operations.

21 LCD panel (p. 10)

22 Control buttons (p. 11)

23 Ready-light

Lights up when the SB-80DX is fully recycled and ready to fire. Blinks after the SB-80DX fires at its maximum output in various auto flash modes, indicating that the light may be insufficient.

24 Mounting foot lock lever (p. 20)

LCD panel

For reference, all indications are displayed in the illustration.

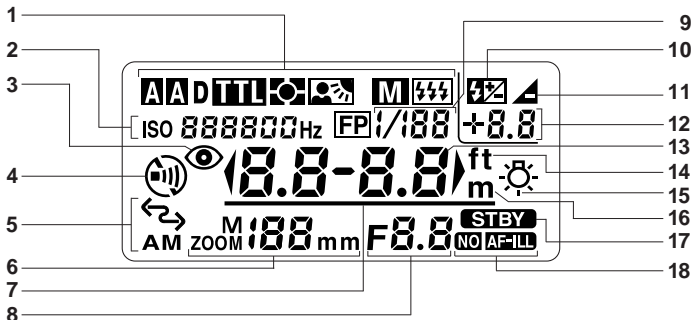

1 Flash mode (pp. 34-51)

- TTL** Automatic Balanced Fill-Flash with TTL Multi Sensor
- D TTL** Automatic Balanced Fill-Flash with TTL Multi Sensor for Digital SLRs
- TTL** Matrix Balanced Fill-Flash, Center-Weighted Fill-Flash/Spot Fill-Flash
- D TTL** Center-Weighted Fill-Flash for Digital SLRs
- TTL** Standard TTL Flash, Matrix Balanced Fill-Flash, Center-Weighted Fill-Flash/Spot Fill-Flash
- D TTL** Standard TTL Flash for Digital SLRs
- A** Non-TTL Auto Flash
- AA** Auto Aperture Flash
- M** Manual Flash
- M** Repeating Flash
- M** FP High-Speed Flash sync

2 ISO sensitivity (p. 22), No. of repeating flashes/Frequency (p. 48)

- 3 Red-eye reduction (p. 60)
- 4 Sound monitor (p. 89)
- 5 Wireless flash (p. 84)
- 6 Zoom-head position (p. 24)
- 7 Underbar (p. 21)
- 8 Aperture (p. 40)
- 9 Flash output level (p. 46)
- 10 Exposure compensation (p. 58)
- 11 Underexposure (p. 31)
- 12 Flash output level compensation value (p. 58)/Underexposure value (p. 31)
- 13 Flash shooting distance range (p. 28)
- 14 ft (feet) (p. 13)
- 15 LCD panel illuminator (p. 13)
- 16 m (meters) (p. 13)
- 17 Standby function (p. 19)
- 18 AF-assist illuminator (p. 62)

About the LCD panel

- Because of the directional characteristics of the liquid crystal, the LCD is difficult to read when viewed diagonally from above; however, the display can be seen clearly from a somewhat lower angle.
- The LCD panel display tends to be darker at high temperatures (approx. 60°C/140°F). When the temperature returns to normal (20°C/68°F), the display also returns to normal.
- The LCD's response time tends to slow down at low temperatures (approx. 5°C/41°F and below). When the temperature returns to normal (20°C/68°F), response time also returns to normal.

Using the SB-80DX in dim light

Press any button on the SB-80DX to turn the illuminator on (when the SB-80DX power is on), and it will stay on for approx. 16 seconds. To cancel the LCD panel illuminator, go to the Custom settings mode and set it to OFF (p. 13).

Control buttons

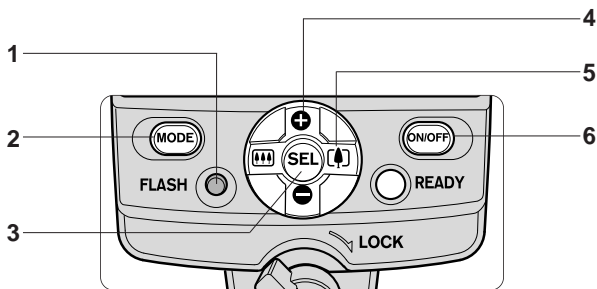

1 **FLASH** button

Press to test fire the flash (p. 18).

2 **MODE** button

Press to set the flash mode (p. 28).

3 **SEL** button

- Press to select these functions: Flash output level compensation, aperture, number of repeating flashes per frame, frequency, and flash output level. The selected item blinks and can be set using the **+** and **-** buttons.
- Press for approx. 2 sec. to display the Custom settings mode (p. 12).

4 **+** button/**-** button





Press to increase or decrease values.

5 **☰** button (**wide**)/ **📷** button (**tele**)

Press to change the zoom-head position (p. 24).









6 **ON/OFF** button

Press for approx. 0.5 sec. to turn the power on and off.

 + 	Press the MODE and SEL buttons simultaneously To recall the underexposure value in the TTL/D-TTL auto flash mode (p. 31).
 + 	Press the MODE and ON/OFF buttons simultaneously for approx. 2 sec. To reset all settings, including custom settings, to their default settings (except the distance unit selected in m/ft).

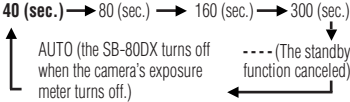
Custom settings

The SB-80DX can easily set, activate, or cancel various operations using the Custom settings function as shown below.

Item	Setting (Bold: default)
 Wireless flash mode*1 (p. 84)	OFF (canceled) ON (activated)
 Sound monitor*2 in the wireless flash mode (p. 89)	••• (sound on)  (sound off)
 AF-assist illuminator (p. 62)	AF ILL (activated) NO AF ILL (canceled)
 Standby function (p. 19)	40 (sec.) → 80 (sec.) → 160 (sec.) → 300 (sec.) 
 Selecting the distance unit (m, ft) (p. 13)	m (meters) ft (feet)
 Canceling the power zoom function (p. 25)	OFF (activated) ON (canceled)
 Emergency mode*3 (p. 98)	OFF (not possible) ON (possible)
 LCD panel illuminator (p.13)	ON (turn on) OFF (turn off)

*1 No display appears when the SB-80DX is attached to Digital SLRs cameras.

*2 The display appears when the wireless flash mode is set to ON.

*3 No display appears when the built-in wide-flash adapter is not used.

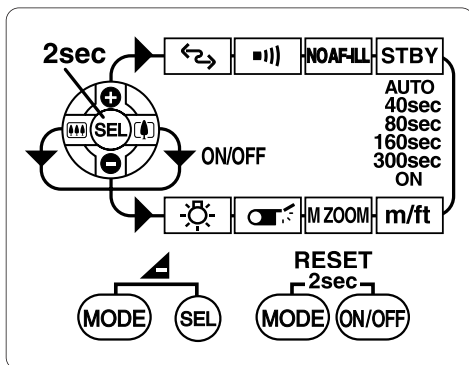





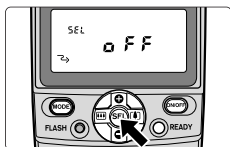

Control button quick reference

Procedures for Custom settings, recalling the underexposure value in the TTL auto flash mode, and resetting all settings to their default settings are shown in the Control button quick reference chart on the back of the built-in bounce card.

◆ Setting the LCD panel illuminator using Custom settings

- 1 Press the  button for approx. 2 sec. to display the Custom settings mode.





- 2 Press the  or  button to choose the  LCD panel illuminator setting.
3 Press the  or  button to turn the LCD panel illuminator on or off.

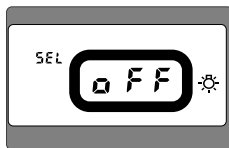

ON (turn on)



OFF (turn off)





- 4 To get out of the custom settings mode, press the  button for approx. 2 sec. or press the  button.

• Even if the LCD panel illuminator is set to OFF, the SB-80DX's LCD panel illuminator turns on when the camera's LCD panel illuminator is turned on. The LCD panel illuminator also lights up when the Custom settings mode is displayed.

◆ Selecting the distance unit (m or ft) using Custom settings

Set the distance unit on the LCD panel to either meters "m" or feet "ft".

• The SB-80DX is preset to meters when the SB-80DX is shipped from the factory.



- 1 Press the  button for more than 2 sec. to display the Custom settings mode.
2 Press the  or  button to choose "Selecting the distance unit (m, ft)."
3 Press the  or  button to set the preferred distance unit.



m (meters) display



ft (feet) display

- 4 Press the  button for more than 2 sec. or press the  button to return to the normal setting mode.

Lenses

In this manual, Nikkor lenses are divided into two types: CPU Nikkor lenses and non-CPU Nikkor lenses.

CPU Nikkor lenses	G-type Nikkor, D-type Nikkor, Non-G/D-type AF Nikkor (except for AF Nikkor for the F3AF), AI-P Nikkor
Non-CPU Nikkor lenses	AI-S Nikkor, AI Nikkor, Series E

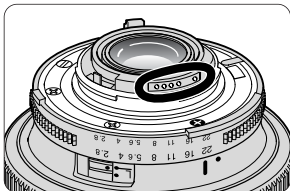

CPU lenses

CPU lenses have CPU contacts.

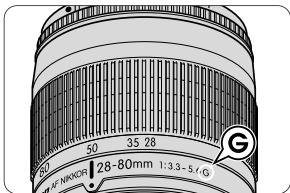

G-type Nikkor lenses

G-type Nikkor lenses send distance information to the camera body, but do not have an aperture ring. Therefore, set the aperture on the camera body. With some cameras, the usable exposure mode is limited. For more details, refer to the lens instruction manual.

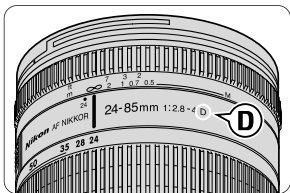

D-type Nikkor lenses

D-type Nikkor lenses send distance information to the camera body. Set the aperture either on the lens aperture ring or on the camera body. For more details, refer to the lens instruction manual.

Basic operation

In this section, basic procedures are clearly illustrated so that you can easily perform flash photography in the TTL/D-TTL auto flash mode.

For more details on other flash modes, refer to “Detailed operation” (p. 33).

1

Installing batteries

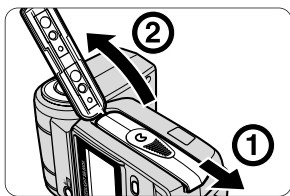

- 1** Open the battery chamber lid as indicated by the arrows.

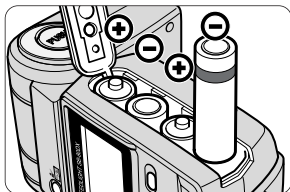

- 2** Install the batteries following the ⊕ and ⊖ marks as shown. Then close the battery chamber lid by sliding it into place while pressing down.

◆ Usable batteries

- Install four AA-type penlight batteries (1.5V or lower) of any of these types:
 - (1) Alkaline-manganese (1.5V)
 - (2) Lithium (1.5V)
 - (3) NiCd (rechargeable, 1.2V)
 - (4) Ni-MH (Nickel Metal Hydride) (rechargeable, 1.2V)
- When replacing batteries, use fresh batteries of the same brand.
- High-power manganese batteries are not recommended for use with the SB-80DX.
- Always carry extra batteries when traveling.
- Refer to “Notes on batteries” on page 96.

CAUTION!

- Do not use batteries not specified in this instruction manual, as this may cause them to explode, leak corrosive liquids, or catch on fire.
- Do not mix battery brands or types, or use old with new batteries. Otherwise the batteries may explode, leak corrosive liquids, or catch on fire.
- Do not recharge non-rechargeable batteries in a battery charger. Otherwise the batteries may leak corrosive liquids, or generate heat.

Minimum number of flashes and recycling times

- When using four fresh batteries of the same type, after the Speedlight fires at M1/1 output.

Batteries	Min. recycling time (approx.)	Min. number of flashes/ recycling time
Alkaline-manganese	6.0 sec.	150 / 6 – 30 sec.
Lithium	7.5 sec.	190 / 7.5 – 30 sec.
NiCd (1000 mAh)	4.0 sec.	90 / 4 – 30 sec.
Ni-MH (1600 mA)	4.0 sec.	110 / 4 – 30 sec.

- Minimum recycling time is for operation using fresh batteries.
- The data was measured without using AF-assist illuminator, zoom-head position adjustment, or LCD panel illumination.
- The above data may vary due to variations in battery performance.

◆ Replacing / recharging the batteries

- Refer to the following table to determine when to replace or recharge your batteries, if the ready-light takes a long time to light up.

Type of battery	Recycling time	Remedy
Alkaline-manganese	More than 30 seconds	Replace
Lithium	More than 10 seconds	
Ni-Cd (rechargeable)	More than 10 seconds	Recharge
Ni-MH(rechargeable)		

- If extremely exhausted batteries are used, a strange sound can be heard caused by the flash head zooming back and forth even when the SB-80DX is turned off. In this case, replace the SB-80DX's batteries even if an external battery source is used.

◆ External power sources

- Using an external power source increases the number of flash firings and provides faster recycling times (p. 94).

2

Test firing (confirming exposure)

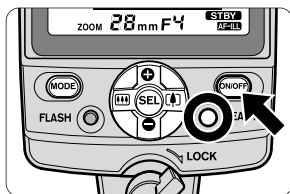

- 1 Press the **ON/OFF** button for approx. 0.5 sec. to turn on the SB-80DX. Make sure the ready-light comes on.

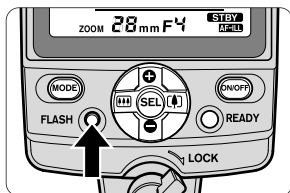

- 2 Press the **FLASH** button to test fire the flash.

◆ Test firing

CAUTION!

When test firing the Speedlight, never position your eyes close to the flash head.

- The SB-80DX fires at specified output in the Manual flash mode or at approx. 1/16 output in the TTL/D-TTL auto flash mode.
- In the Non-TTL auto flash/Auto Aperture flash modes, the SB-80DX fires at a flash output controlled by the ISO sensitivity, aperture, and zoom-head position.
- In the Non-TTL auto/Auto Aperture flash mode, you can check the amount of insufficient flash output by pressing the **FLASH** button before taking the actual picture (p. 54).

◆ **ON/OFF** button

- Pressing the **ON/OFF** button for approx. 0.5 sec. turns the SB-80DX on and the indications appear on the LCD panel. Pressing the button again turns the SB-80DX off and the indications disappear.

◆ Standby function to conserve battery power

- If the SB-80DX and the camera are not used for approx. 40 seconds, the standby function activates and automatically turns the SB-80DX off to conserve battery power (standby-off state).
- Only the **STBY** indicator appears on the LCD panel in the standby-off state.
- The SB-80DX in the standby-off state returns to on again when the SB-80DX's **ON/OFF** or **FLASH** button is pressed, or the shutter release button is lightly pressed (when using a camera body that is compatible with TTL/D-TTL auto flash) (p. 36).
- In the Wireless Flash mode (p. 84), the standby function activates in approx. 40 seconds when the Speedlight is attached to the camera body. However, the standby function does not work regardless of the SB-80DX's setting when the Speedlight is used as a slave flash unit.
- If the ready-light does not come on in approx. 60 seconds after turning the power on, the SB-80DX goes into standby-off state and the **STBY** indicator appears.
- To avoid accidental firing or a malfunction when carrying the SB-80DX in your camera bag, press the **ON/OFF** button to turn the flash unit off and make sure the **STBY** indicator disappears.

Adjusting standby duration/canceling standby function using Custom settings

- 1 Press the **SEL** button for more than 2 sec. to display the Custom settings mode.
- 2 Press the **+** or **-** button to choose "Standby function."
- 3 Press the **MEM** or **DISP** button to set the appropriate standby duration.

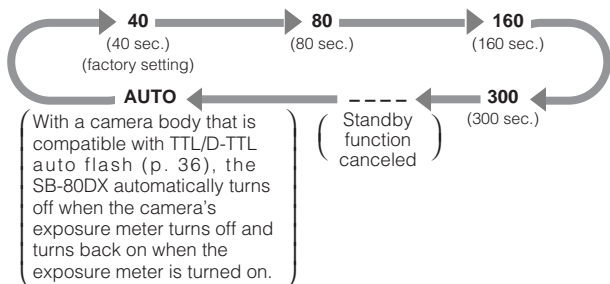

- 4 Press the **SEL** button for more than 2 sec. or press the **ON/OFF** button to return to the normal setting mode.

3

Attach the SB-80DX to the camera and

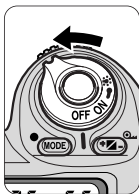
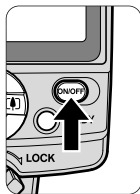

- 1 Make sure the SB-80DX and the camera body are turned off.

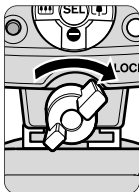
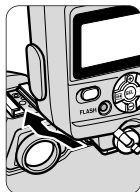

- 2 Rotate the mounting foot lock lever to the left, slide the SB-80DX's mounting foot into the camera's accessory shoe and turn the lock lever to the right.

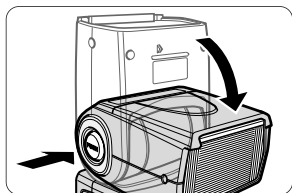

- 3 Hold down the flash head tilting/rotating lock release button to adjust the flash head to the horizontal/front position.

◆ Turn the mounting foot lock lever securely until it stops.

- To lock the Speedlight in place, turn the lock lever approx. 90° clockwise until it stops. To unlock, turn the lever counterclockwise until it stops.



Lock



Unlock

adjust the flash head

◆Warning indication

- If the flash head is not adjusted to the horizontal/front position, when the power is turned on, this warning appears on the LCD panel. See page 68 for the flash head's rotating angles.

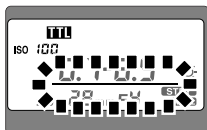

The underbar blinks when the flash head is tilted down -7° .

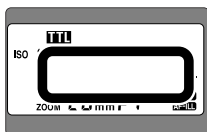

The flash shooting distance range disappears if the flash head is adjusted to other than the horizontal/front or down -7° position.

◆The ready-light only inside the camera's viewfinder blinks after the power is turned on:

Camera group/camera name	Possible cause
Cameras in Groups I to VI (except F70-Series/N70)	In the TTL auto flash mode, the SB-80DX is not properly attached to the camera body.
Cameras in Groups V and VI	In the TTL auto flash mode, the ISO film speed set on the camera is higher than the available range of the Speedlight. <ul style="list-style-type: none">• The ISO film speed set on the camera is higher or lower than the available range for the FA camera only.
Cameras in Group VI	In the TTL auto flash mode, the shutter speed is set to M90, M250, or B (bulb).
FM3A, New FM2	The shutter speed set is faster than the flash sync speed.
New FM2, F55/N55	The SB-80DX's flash mode is set to TTL auto flash.

4

Setting the ISO sensitivity

In this manual, the film speed for film-based cameras and the sensitivity for Digital SLRs cameras are generally referred to as ISO sensitivity.

- For cameras in Groups I and II, and Digital SLRs cameras, the ISO sensitivity is automatically set and appears on the LCD panel.
- For other camera bodies, set the ISO sensitivity using the following procedure.

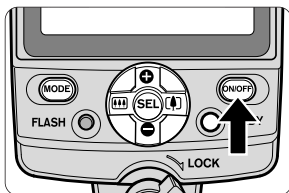

- 1** Turn the SB-80DX off once, then turn it back on. After that, turn on the camera body.

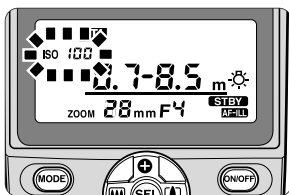

- 2** The ISO sensitivity starts blinking on the LCD panel.
 - No setting is possible if the SEL button is pressed to stop the ISO sensitivity from blinking. In this case, return to step 1 above.

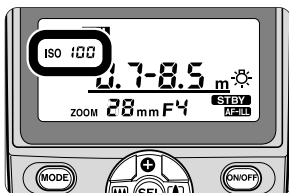

- 3** Press the \oplus or \ominus button to increase or decrease the ISO sensitivity.
- 4** Press the SEL button to stop the ISO sensitivity from blinking.

Digital data communication with the SB-80DX

When the SB-80DX is used with cameras in Groups I and II, and Nikon Digital SLRs cameras, digital data communication is performed. The camera automatically sends the ISO sensitivity to the SB-80DX. With a CPU lens, the aperture and focal length are automatically set on the SB-80DX.

◆ Available ISO sensitivity in TTL/D-TTL auto flash operation

- The maximum ISO sensitivity range usable in the TTL/D-TTL auto flash mode is ISO 25 to 1000.
- The ISO sensitivity range may become narrower, depending on the cameras in use. For details, see your camera instruction manual.
- The flash shooting distance range on the SB-80DX's LCD panel varies, depending on the ISO sensitivity. Therefore, be sure to set the ISO sensitivity correctly.

Notes on setting the Speedlight's ISO sensitivity

In the TTL/D-TTL auto flash mode and Manual flash mode, there is no direct connection between setting the ISO sensitivity on the Speedlight and controlling the flash output level. Setting the ISO sensitivity is for correctly displaying the flash shooting distance range or the shooting distance indication on the Speedlight's LCD panel.

In the Non-TTL auto flash mode and Auto Aperture flash mode, the correct exposure can be obtained by setting the camera's ISO sensitivity on the Speedlight, because the Speedlight controls the flash output. In the Auto Aperture flash mode, the ISO sensitivity is automatically transferred from the camera to the Speedlight.

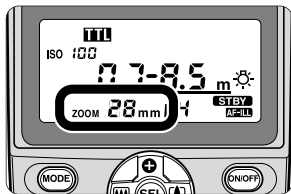

1 The zoom-head position is indicated on the LCD panel.

- The zoom-head position is automatically adjusted by the power zoom function or it can be manually adjusted.
- The guide number indicating flash output level varies according to the zoom-head position (p. 45).

◆ The power zoom function

- When the SB-80DX is used with cameras in Groups I, II, or Nikon Digital SLRs, in combination with a CPU lens, the power zoom function activates and the zoom head is automatically adjusted.
- The zoom-head position is automatically adjusted within the range of 24mm, 28mm, 35mm to 105mm in increments of 5mm between 35mm and 105mm when the power zoom function is activated.
- When the lens focal length is not one of those indicated above, the zoom head adjusts to the closest wideangle setting of the lens in use. For example, if the zoom setting of a CPU lens is between 36mm and 39mm, the zoom-head position is adjusted to 35mm.
- If a small **M** does not appear above the "ZOOM" indication on the LCD panel, the zoom-head position will be automatically adjusted. If a small **M** appears, press the or button several times until it disappears.

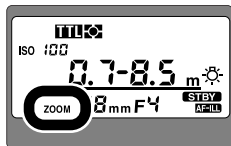

Power zoom activated

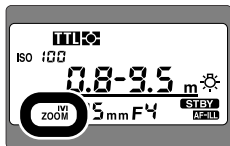

Power zoom canceled

◆ Setting the zoom-head position manually

- When the SB-80DX is used with cameras in Groups III to VII in combination with a non-CPU lens, or you want to change the zoom-head position to one that does not match the focal length, you should adjust the zoom-head position manually.
- Press the button to move toward a wideangle setting and the button to move toward a telephoto setting.
- When the camera/lens combination is compatible with the power zoom function, the zoom-head position changes as follows, when a 35mm lens is attached:

M24mm↔M28mm↔35mm↔M50mm↔M70mm↔M85mm↔M105mm

- A small M above the “ZOOM” indication appears on the LCD panel while manually setting the zoom-head position.
- Generally, set the zoom-head position to the focal length of the lens in use or to the closest wideangle setting.
For example, select the 50mm setting when using a 60mm lens.

◆ Canceling the power zoom function using Custom settings

- When the power zoom function is canceled in the Custom settings mode (p. 12), the small M blinks and the zoom-head position indicator does not change even if the lens is zoomed, a lens is changed, or the **ON/OFF** button is pressed.
- The zoom head can manually be adjusted to 24mm, 28mm, 35mm, 50mm, 70mm, 85mm, or 105mm by pressing the **W** or **T** button.
- Press the **W** button to move toward a wideangle setting and the **T** button to move toward a telephoto setting. The zoom-head position changes as follows:

24mm↔28mm↔35mm↔50mm↔70mm↔85mm↔105mm

- 1 Press the **SEL** button for more than 2 sec. to display the Custom settings mode.
- 2 Press the **+** or **-** button to choose “Canceling the power zoom function.”
- 3 Press the **W** or **T** button to select “ON.”



- 4 Press the **SEL** button for more than 2 sec. or press the **ON/OFF** button to return to the normal setting mode.

◆ Using the built-in wide-flash adapter/ Nikon Diffusion Dome

- Use the built-in wide-flash adapter when a 14mm to 23mm lens is mounted (p. 72).
- The power zoom function becomes inactive when using the wide-flash adapter. Press the **W** or **T** button to adjust the zoom-head position to 14mm or 17mm.
- The zoom-head position is automatically set at 14mm when the Nikon Diffusion Dome is attached.
- When using a 14mm or 17mm lens or the Nikon Diffusion Dome, the distance between the camera and subject becomes increasingly pronounced from the center of the frame to the periphery, so the peripheral area might not be sufficiently lit in some cases.

6

Setting the camera's exposure mode and

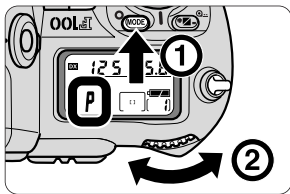

1 Set the camera's exposure mode to Programmed Auto (P).

- If Programmed Auto (P) cannot be set, refer to page 27 to select another exposure mode.

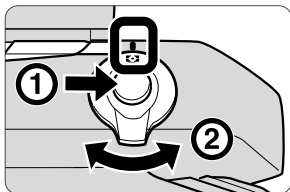

2 Set the camera's metering system to Matrix Metering.

- If Matrix Metering cannot be set, select Center-Weighted Metering.

◆ Exposure mode and metering system

- The camera's available exposure mode and metering system vary, depending on the cameras and lenses in use or the SB-80DX's flash modes. For details, refer to "Detailed operation" (p. 33) and your camera's instruction manual.
- In Programmed Auto (P) mode, the shutter speed is automatically set to the highest flash sync shutter speed.

◆ Exposure modes other than Programmed Auto exposure (P)

In Shutter-Priority Auto exposure (S) mode

- By selecting a slower shutter speed, the proper exposure for the background can be achieved.
- The camera selects the correct aperture. Set the shutter speed on the camera after confirming that the automatically controlled aperture will provide an appropriate shooting distance range for your subject. Refer to "Flash shooting distance range in the TTL/D-TTL auto flash modes" (p. 29).
- If you set a shutter speed faster than the flash sync speed, the camera automatically shifts to its fastest sync speed when the SB-80DX is turned on.

In Aperture-Priority Auto exposure (A) mode

- By selecting the aperture, you can control depth of field and the flash shooting distance range.
- The camera selects the correct shutter speed. For details, see your camera's instruction manual.
- To determine the aperture, refer to the guide number (p. 45) and the "Flash shooting distance range in the TTL/D-TTL auto flash modes" (p. 29).

In Manual exposure (M) mode

- By selecting the shutter speed and aperture, you can control the exposure of the background, the depth of field, and flash shooting distance range.
- If you set a shutter speed faster than the flash sync speed, the camera automatically shifts to its fastest sync speed when the SB-80DX is turned on. This is true of all cameras, except mechanical shutter cameras.
- To determine the aperture, refer to the "Guide number" (p. 45) and the "Flash shooting distance range in the TTL/D-TTL auto flash modes" (p. 29).

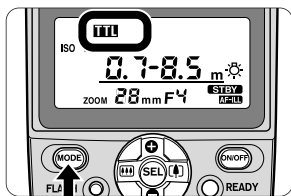

- 1 Press the **MODE** button to set the flash mode to TTL/D-TTL auto flash.

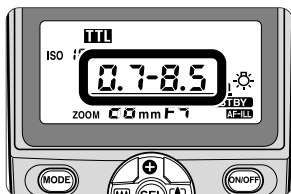

- 2 Confirm that the main subject is within the flash shooting distance range.

◆ TTL/D-TTL auto flash mode (p. 35)

- Every time you press the MODE button, the flash mode changes. In the TTL auto flash mode, the **TTL** indicator appears on the LCD panel.
- When using Nikon Digital SLRs cameras, D-TTL auto flash is activated and **D TTL** appears on the LCD panel.

For film-based cameras



For Digital SLRs cameras



- Note that the usable flash modes only appear and vary, and the unavailable TTL/D-TTL auto flash modes will be skipped and do not appear, when pressing the MODE button.
- The SB-80DX's available flash modes vary, depending on the cameras and lenses in use or the camera's exposure mode and metering system. Refer to "Detailed operation" (p. 33) and your camera's instruction manual.

◆ About the flash shooting distance range

- The SB-80DX's flash shooting distance range is 0.6m to 20m (2 to 66 ft.) and varies, depending on the ISO sensitivity, zoom-head position and lens aperture in use.

Flash shooting distance range in the TTL/D-TTL auto flash modes

		ISO sensitivity							Zoom-head position (mm)										
		1600	800	400	200	100	50	25	*1	*2	14 ^{*3}	17 ^{*3}	24	28	35	50	70	85	105
Aperture	*4																		
	2.8	2	1.4																
	4	2.8	2	1.4															
	5.6	4	2.8	2	1.4				0.8-9.0/ 2.6-29	1.0-11/ 3.3-37	1.1-12/ 3.5-39	1.2-13/ 3.9-44	2.0-20/ 6.6-66	2.1-20/ 7.0-66	2.4-20/ 7.8-66	2.8-20/ 9.3-66	3.0-20/ 10-66	3.4-20/ 11-66	3.6-20/ 12-66
	8	5.6	4	2.8	2	1.4		0.6-6.3/ 2.0-21	0.7-8.0/ 2.3-26	0.7-8.5/ 2.5-28	0.8-9.5/ 2.8-31	1.4-16/ 4.6-52	1.5-17/ 4.9-56	1.7-19/ 5.5-62	2.0-20/ 6.6-66	2.2-20/ 7.4-66	2.4-20/ 7.8-66	2.5-20/ 8.3-66	
	11	8	5.6	4	2.8	2	1.4	0.6-4.5/ 2.0-15	0.6-5.7/ 2.0-19	0.6-6.0/ 2.0-20	0.6-6.7/ 2.0-22	1.0-11/ 3.3-37	1.1-12/ 3.5-39	1.2-13/ 3.9-44	1.4-16/ 4.6-52	1.6-18/ 5.2-59	1.7-19/ 5.5-62	1.8-20/ 5.8-66	
	16 ^{*5}	11	8	5.6	4	2.8	2	0.6-3.2/ 2.0-10	0.6-4.0/ 2.0-13	0.6-4.2/ 2.0-14	0.6-4.8/ 2.0-16	0.7-8.0/ 2.3-26	0.7-8.5/ 2.5-28	0.8-9.5/ 2.8-31	1.0-11/ 3.3-37	1.1-13/ 3.7-42	1.2-13/ 3.9-44	1.3-14/ 4.1-47	
	22	16	11	8	5.6	4	2.8	0.6-2.2/ 2.0-7.4	0.6-2.8/ 2.0-9.3	0.6-3.0/ 2.0-10	0.6-3.4/ 2.0-11	0.6-5.7/ 2.0-19	0.6-6.0/ 2.0-20	0.6-6.7/ 2.0-22	0.7-7.6/ 2.3-26	0.8-9.0/ 2.6-29	0.8-9.5/ 2.8-31	0.9-10/ 2.9-33	
	32	22	16	11	8	5.6	4	0.6-1.6/ 2.0-5.2	0.6-2.0/ 2.0-6.6	0.6-2.1/ 2.0-7.0	0.6-2.4/ 2.0-7.8	0.6-4.0/ 2.0-13	0.6-4.2/ 2.0-14	0.6-4.8/ 2.0-16	0.6-5.3/ 2.0-19	0.6-6.3/ 2.0-21	0.6-6.7/ 2.0-22	0.6-7.1/ 2.1-23	
		32	22	16	11	8	5.6	0.6-1.1/ 2.0-3.7	0.6-1.4/ 2.0-4.6	0.6-1.5/ 2.0-4.9	0.6-1.7/ 2.0-5.5	0.6-2.8/ 2.0-9.3	0.6-3.0/ 2.0-10	0.6-3.4/ 2.0-11	0.6-4.0/ 2.0-13	0.6-4.5/ 2.0-15	0.6-4.8/ 2.0-16	0.6-5.0/ 2.0-17	
		32	22	16	11	8	0.6-0.8/ 2.0-2.6	0.6-1.0/ 2.0-3.3	0.6-1.1/ 2.0-3.5	0.6-1.2/ 2.0-3.9	0.6-2.0/ 2.0-6.6	0.6-2.1/ 2.0-7.0	0.6-2.4/ 2.0-7.8	0.6-2.8/ 2.0-9.3	0.6-3.2/ 2.0-10	0.6-3.4/ 2.0-11	0.6-3.6/ 2.0-12		
			32	22	16	11	-	0.6-0.7/ 2.0-2.3	0.6-0.7/ 2.0-2.5	0.6-0.8/ 2.0-2.8	0.6-1.4/ 2.0-4.6	0.6-1.5/ 2.0-4.9	0.6-1.7/ 2.0-5.5	0.6-2.0/ 2.0-6.6	0.6-2.2/ 2.0-7.4	0.6-2.4/ 2.0-7.8	0.6-2.5/ 2.0-8.3		
				32	22	16	-	-	-	-	0.6-1.0/ 2.0-3.3	0.6-1.1/ 2.0-3.5	0.6-1.2/ 2.0-3.9	0.6-1.4/ 2.0-4.6	0.6-1.6/ 2.0-5.2	0.6-1.7/ 2.0-5.5	0.6-1.8/ 2.0-5.8		

Flash shooting distance range (m/ft.)

*1 With the Nikon Diffusion Dome attached and the wide-flash adapter in place

*2 With the Nikon Diffusion Dome attached

*3 With the wide-flash adapter in place

*4 TTL/D-TTL auto flash operation is not possible at this ISO sensitivity.

For ISO 1000, use an aperture 2/3 of an f/stop smaller than the aperture for ISO 1600, or 1/3 larger than the aperture for ISO 800.

*5  Programmed TTL Auto Flash with the F-501/N2020, F-401s/N4004s, F-401/N4004, and F-301/N2000. (ISO 25 to ISO 400 for the F-401s/N4004s and F-401/N4004.)

8

Compose the picture and shoot with flash

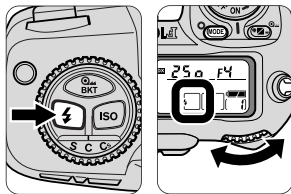

- 1** Set the camera's sync mode.
- In normal flash photography, set the camera's flash sync mode to Front-curtain sync.

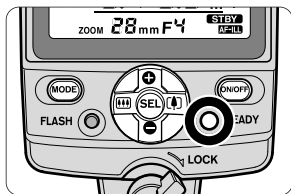

- 2** Compose the picture, confirm that the ready-light on the SB-80DX's LCD panel or in the camera's viewfinder is on, then shoot.

◆ Set the camera's flash sync mode to Front-curtain sync.

- Set the camera's flash sync mode to Front-curtain sync with cameras featuring a Rear-curtain sync flash mode.
- For other flash sync modes, refer to "Slow-sync flash mode" (p. 60), "Red-eye reduction with slow-sync flash mode" (p. 60), or "Rear-curtain sync flash" (p. 61).
- Refer to the camera's instruction manual for details on the flash sync mode.

◆ If the ready-light blinks after shooting, the light might be insufficient.

- In various auto flash modes, when the flash has fired at its maximum output and underexposure may have occurred, the ready-lights on the SB-80DX and in the camera's viewfinder blink for approx. 3 sec. Depending on the camera in use, the ready-light on the SB-80DX or in the camera's viewfinder lights up. To compensate, use a wider aperture or move closer to the subject and reshoot.

Display of the amount of underexposure

- With cameras in Group I and Nikon Digital SLRs cameras in the TTL/D-TTL auto flash mode, the amount of underexposure (0 to -3.0 EV) appears for approx. 3 sec on the SB-80DX's LCD panel; at the same time the ready-lights blink.
- Pressing the **MODE** and **SEL** buttons simultaneously recalls this display.



Using the SB-80DX with the COOLPIX

 COOLPIX 900 series (COOLPIX 995, etc.) and COOLPIX 5000 digital cameras have a built-in compact flash unit. When more powerful illumination is required, or when performing multiple flash, connecting the SB-80DX or another Nikon Speedlight to the COOLPIX using cords is recommended as an external flash unit.

Auto flash operation is possible by setting the SB-80DX's flash mode to the TTL auto flash mode. The flash output level is controlled by detecting signals from the camera to determine when to start and stop firing in sync with the built-in flash, which is controlled by the camera's Non-TTL auto flash operation.

- Use the dedicated Multi-Flash Bracket Unit SK-E900 (optional) and Multi-Flash Adapter AS-E900 (optional) for connection with all the COOLPIX 900 series cameras except the COOLPIX 900 itself.
- For connection to the COOLPIX 5000, attach the Speedlight directly to the accessory shoe.

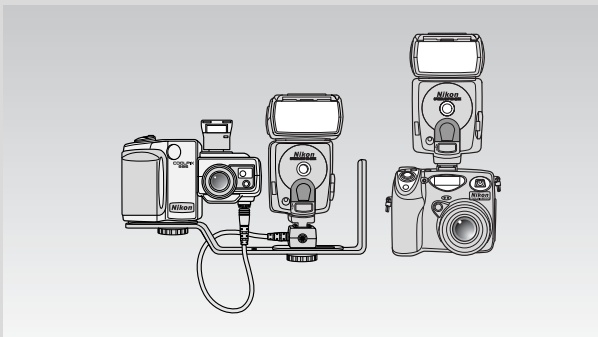

Please note that wireless multiple flash using the COOLPIX's built-in flash as a master flash unit and the SB-80DX as a slave flash unit cannot be performed.

Detailed operation

This section provides a variety of flash modes available with the SB-80DX.

Be sure to refer to your camera's instruction manual for specific information on camera settings and functions.

SB-80DX available flash modes

The SB-80DX's available flash modes vary, depending on the cameras and lenses in use or the camera's exposure mode.

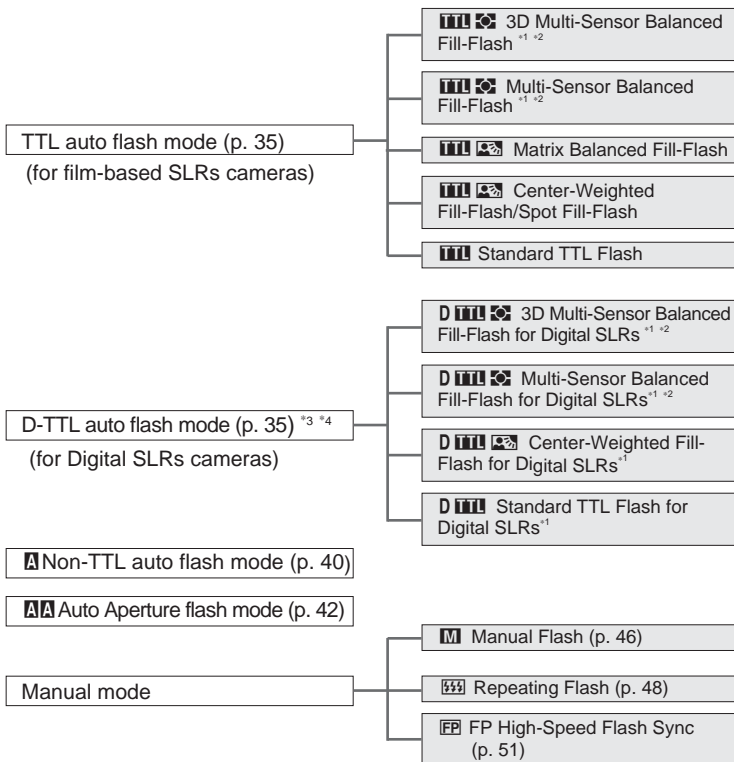

*1 Monitor Preflashes are fired.

*2 3D Multi-Sensor Balanced Fill-Flash and Multi-Sensor Balanced Fill-Flash are generally referred to as Automatic Balanced Fill-Flash with TTL Multi Sensor (Automatic Balanced Fill-Flash with TTL Multi-Sensor for Digital SLRs in D-TTL auto flash).

*3 The TTL auto flash mode for Nikon Digital SLRs is called the D-TTL auto flash mode.

*4 In the D-TTL auto flash mode, Monitor Preflashes are fired at all times.

TTL/D-TTL auto flash mode

The SB-80DX's TTL/D-TTL auto flash mode varies, depending on the cameras and lenses in use or the camera's exposure mode and metering system. For details, refer to "Usable cameras compatible with the TTL/D-TTL auto flash mode" (p. 36) and your camera's instruction manual.

TTL **3D Multi-Sensor Balanced Fill-Flash/**

D TTL **3D Multi-Sensor Balanced Fill-Flash for Digital SLRs**

Information obtained by the Monitor Preflashes, exposure control information, and distance information from a D- or G-type lens are integrated to automatically adjust the flash output level to obtain a well-balanced exposure of the main subject and background.

TTL **Multi-Sensor Balanced Fill-Flash/**

D TTL **Multi-Sensor Balanced Fill-Flash for Digital SLRs**

Information obtained by the Monitor Preflashes and exposure control information is integrated to automatically adjust the flash output level for a well-balanced exposure of the main subject and background.

TTL **Matrix Balanced Fill-Flash**

Exposure control information obtained by the camera's Matrix meter is used to automatically adjust the flash output level for a well-balanced exposure of the main subject and background.

TTL **Center-Weighted Fill-Flash/Spot Fill-Flash**

Exposure control information with Center-Weighted or Spot Metering is used to adjust the flash output for a natural fill-flash effect.

D TTL **Center-Weighted Fill-Flash for Digital SLRs**

Exposure control information with Center-Weighted Metering is used to adjust the flash output for a natural fill-flash effect.

TTL **Standard TTL Flash/D TTL** **Standard TTL Flash for Digital SLRs**

The main subject is correctly exposed regardless of the background brightness. Useful when you want to highlight the main subject.

◆ **Balancing the exposure for the main subject and background**

- The degree of exposure balance for the main subject and the background varies as the type of TTL auto flash mode changes. The most well-balanced TTL auto flash exposure is obtained when using 3D Multi-Sensor Balanced Fill-Flash and decreases through Multi-Sensor Balanced Fill-Flash, Matrix Balanced Fill-Flash, Center-Weighted/Spot Fill-Flash, down to Standard TTL Flash in that order.
- The above description is applicable to the D-TTL auto flash mode.

◆ **Monitor Preflashes**

- Monitor Preflashes are available in Automatic Balanced Fill-Flash with TTL Multi-Sensor and all flash modes in D-TTL auto flash to determine the condition of the subject. After you press the shutter release button and just before the shutter opens, the SB-80DX fires a series of imperceptible preflashes that are detected by the camera's TTL Multi-Sensor and analyzed for brightness and contrast. (Please note that Monitor Preflashes are fired instantaneously and cannot be differentiated from the main flash.)
- To cancel Monitor Preflashes, see page 74.

Usable cameras compatible with the TTL/D-TTL

The available types of TTL/D-TTL auto flash vary, depending on the camera/lens/exposure mode/metering system being used. For details, see the tables on the following pages.

- Refer to your camera's instruction manual for specific information on camera settings and functions.

Exposure mode

P : Programmed Auto
S : Shutter-Priority Auto
A : Aperture-Priority Auto
M : Manual

TTL/D-TTL auto flash mode

: Automatic Balanced Fill-Flash with TTL Multi Sensor
 : Matrix Balanced Fill-Flash, Center-Weighted Fill-Flash/Spot Fill-Flash
 : Standard TTL Flash

Metering system

: Matrix
 : Center-Weighted
 : Spot

D : Automatic Balanced Fill-Flash with TTL Multi Sensor for Digital SLRs
D : Center-Weighted Fill-Flash for Digital SLRs
D : Standard TTL Flash for Digital SLRs

Cameras compatible with the TTL/D-TTL auto flash mode

Camera Group	Camera	TTL/D-TTL auto flash mode	Exposure mode	Metering system	Lens
I	F5 F100	*2	P/S/A/M		CPU lens (D/G-type)
		*3	P/S/A/M		CPU lens (except for D/G-type)
			A/M		Non-CPU lens
			P/S/A/M		CPU lens
			A/M		Non-CPU lens
	F90X/N90s F90-Series/ N90 F70-Series/ N70	*2	P/S/A/M		CPU lens (D/G-type)*1
			P/S/A/M		CPU lens (except for D/G-type)
			A/M		Non-CPU lens
			P/S/A/M		CPU lens*1
			A/M		Non-CPU lens
	F80-Series/ N80-Series	*2	P/S/A/M		CPU lens (D/G-type)
			P/S/A/M		CPU lens (Non-D/G-type AF)
		P/S/A/M		CPU lens	
		M		Non-CPU lens*1	
*1: The A and M exposure modes cannot be used with a G-type lens. *2: 3D Multi-Sensor Balanced Fill-Flash is set. *3: Multi-Sensor Balanced Fill-Flash is set.					
*1: The camera's exposure meter cannot be used. Set the aperture using the lens aperture ring. *2: 3D Multi-Sensor Balanced Fill-Flash is set. *3: Multi-Sensor Balanced Fill-Flash is set.					

auto flash mode

Camera Group	Camera	TTL/D-TTL auto flash mode	Exposure mode	Metering system	Lens	
II	F4-Series		P/S/A/M		CPU lens ^{*1}	
			A/M		Non-CPU lens ^{*2}	
		^{*3}	P/S/A/M		CPU lens ^{*1}	
		^{*3}	A/M		Non-CPU lens	
			P/S/A/M		CPU lens ^{*1}	
			A/M		Non-CPU lens	
	*1: The A and M exposure modes cannot be used with a G-type lens. *2: AI-S, AI, Series E lens only usable. *3: Center-Weighted Fill-Flash is set.					
	F65-Series/ N65-Series		P/S/A		CPU lens	
			P/S/A/M		CPU lens ^{*1}	
			M		Non-CPU lens ^{*2}	
	*1: Center-Weighted Metering is automatically set when the exposure mode is set to M. *2: The camera's exposure meter cannot be used. Set the aperture using the lens aperture ring.					
F-801s/ N8008s		P/S/A/M		CPU lens ^{*1}		
	^{*3}	P/S/A/M		CPU lens ^{*1/*2}		
	^{*3}	A/M		Non-CPU lens ^{*2}		
	F-801/ N8008		P/S/A/M		CPU lens ^{*1/*2}	
			A/M		Non-CPU lens ^{*2}	
*1: The A and M exposure modes cannot be used with a G-type lens. *2: Spot Metering is not possible with the F-801/N8008. *3: Center-Weighted Fill-Flash/Spot Fill-Flash is set.						
Pronea 600i/6i		P/S/A		CPU lens		
		P/S/A/M		CPU lens		
		M		Non-CPU lens ^{*1}		
*1: The camera's exposure meter cannot be used. Set the aperture using the lens aperture ring.						
III	F-601/ N6006		P/S/A/M		CPU lens (except for G-type) ^{*1}	
			P/S/A/M		CPU lens (except for G-type) ^{*1}	
			A/M		Non-CPU lens ^{*1}	
			P/S/A/M		CPU lens (except for G-type) ^{*2}	
			A/M		Non-CPU lens ^{*2}	
*1: Only appears on the SB-80DX's LCD panel. Matrix Balanced Fill-Flash or Center-Weighted Fill-Flash/Spot Fill-Flash is selected when appears on the camera's LCD panel. *2: Center-Weighted Metering is automatically set when the exposure mode is set to M.						

Usable cameras compatible with the TTL/D-TTL auto flash mode

Camera Group	Camera	TTL/D-TTL auto flash mode	Exposure mode	Metering system	Lens	
III	F-601M/ N6000		P/S		CPU lens ^{*1}	
			P/S		CPU lens ^{*1}	
			A/M		Non-CPU lens ^{*1}	
			P/S		CPU lens	
			A/M		Non-CPU lens	
*1: Only appears on the SB-80DX's LCD panel. Matrix Balanced Fill-Flash or Center-Weighted Fill-Flash/Spot Fill-Flash is selected when appears on the camera's LCD panel.						
IV	F60-Series/N60	^{*1}	P/S/A		CPU lens	
	F50-Series/N50 F-401x/N5005	^{*2}	M		CPU/non-CPU lens	
V	F-501/N2020 F-301/N2000	^{*3}	P		CPU ^{*4} /non-CPU lens ^{*5}	
			A/M		CPU ^{*4} /non-CPU lens	
	*1: Matrix Balanced Fill-Flash is set. *2: Center-Weighted Fill-Flash/Spot Fill-Flash is set. *3: Programmed TTL Auto Flash is set. *4: G-type Nikkor lenses cannot be used. Nikkor lenses for F3AF usable. *5: AI-S, AI, Series E lenses only usable.					
	F-401s/N4004s F-401/N4004	^{*2}	P/S		CPU lens	
			A/M		CPU lens ^{*1}	
		M		Non-CPU lens		
*1: Center-Weighted Metering is automatically set when the exposure mode is set to M. *2: Programmed TTL Auto Flash is set.						
VI	FM3A		A/M		CPU (except G-type)/non-CPU lens	
	FA		P/A/M		CPU (except G-type)/non-CPU lens ^{*1}	
	FE2		A/M		CPU (except G-type)/non-CPU lens ^{*1}	
	FG		P/A/M		CPU (except G-type)/non-CPU lens ^{*1}	
	Nikonos V		A/M		CPU (except G-type)/non-CPU lens ^{*1/2}	
	F3-Series		A/M		CPU (except G-type)/non-CPU lens ^{*3}	
*1: Standard TTL Flash is not possible if the shutter speed is set to M250 or B (bulb) for the FA, FE2, and M90 for the FG and Nikonos V cameras. *2: An optional sync cord for land use is required. *3: Optional TTL Unit Coupler AS-17 is required.						

Digital data communication with the SB-80DX

When the SB-80DX is used with cameras in Groups I and II, and Nikon Digital SLRs cameras listed in the table above, digital data communication is performed. (p. 22)

Camera Group	Camera	TTL/D-TTL auto flash mode	Exposure mode	Metering system	Lens
Digital SLRs	D1-Series	*1	P/S/A/M		CPU lens (D/G-type)
	D100	*2	P/S/A/M		CPU lens (except for D/G-type)
			A/M		Non-CPU lens
			P/S/A/M		CPU lens
			A/M		Non-CPU lens
*1: 3D Multi-Sensor Balanced Fill-Flash for Digital SLRs is set *2: Multi-Sensor Balanced Fill-Flash for Digital SLRs is set					

◆ Flash shooting distance range in the 1/300 TTL High-Speed Flash sync mode (F5 only)

- The farthest flash shooting distance cannot be read on the SB-80DX's LCD panel. In this case, use the guide number table and equation for calculating this distance, according to each zoom-head position.

$$D \text{ (farthest flash shooting distance)} = \text{Guide number} \div f/\text{stop (aperture)}$$

Guide number (m/ft.) in the 1/300 TTL High-Speed Flash sync mode

ISO sensitivity	Zoom-head position (mm)										
	*1	*2	14 ^{*3}	17 ^{*3}	24	28	35	50	70	85	105
25	2.5/8	3/10	3.5/11	3.5/11	5.5/18	6/20	7/23	8/26	9/30	9.5/31	10/33
50	3.6/12	4.3/14	5/16	5/16	7.8/26	8.5/28	9.9/32	11.4/37	12.8/42	13.5/44	14.2/47
100	5/16	6/20	7/23	7/23	11/36	12/39	14/46	16/52	18/59	19/62	20/66
200	7/23	8.4/28	9.8/32	9.8/32	15.4/51	16.8/55	19.6/64	22.4/73	25.2/83	26.6/87	28/92
400	10/33	12/39	14/46	14/46	22/72	24/79	28/92	32/105	36/118	38/125	40/131
800	14/46	16.8/55	19.6/64	19.6/64	30.8/101	33.6/110	39.2/129	44.8/147	50.4/165	53.2/174	56/184

*1 With the Nikon Diffusion Dome attached and the wide-flash adapter in place

*2 With the Nikon Diffusion Dome attached

*3 With the wide-flash adapter in place

- For example, when shooting with an ISO sensitivity of 100, at a 35mm zoom-head position and an aperture of f/5.6:

$$D = 14 \div 5.6 \text{ (f/stop)} = 2.5 \text{ (in meters) (farthest flash shooting distance)}$$

$$D = 46 \div 5.6 \text{ (f/stop)} = 8.2 \text{ (in feet) (farthest flash shooting distance)}$$

Non-TTL auto flash **A** mode

Usable cameras and lenses

Any camera and lens combination. (For Digital SLRs, it is possible only when a non-CPU lens is mounted.)

The SB-80DX's built-in sensor measures the flash illumination reflected back from the subject, automatically controlling the SB-80DX's light output to give the correct exposure. This allows you to make exposure compensation (p. 56) easily by varying the aperture set on the camera or lens.

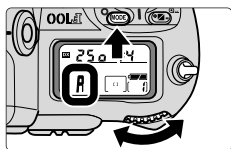

- 1 Set the camera's exposure mode to Aperture-Priority Auto (**A**) or Manual (**M**).

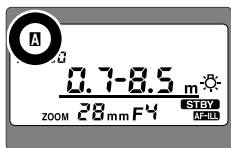

- 2 Press the **(MODE)** button until "**A**" appears on the LCD panel.

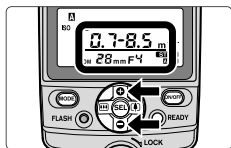

- 3 Press the **+** or **-** button to change the aperture, bringing the subject within the flash shooting distance range.

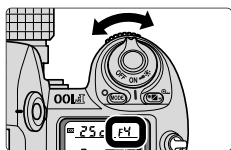

- 4 Set the aperture that appears on the SB-80DX's LCD panel on the lens or camera.

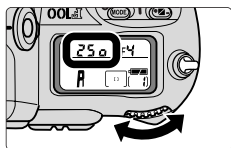

- 5 Set the camera to its highest flash sync shutter speed.
 - For details, see the camera's instruction manual.

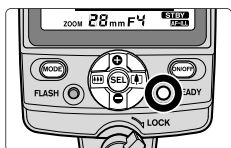

6 Compose the picture, make sure the ready-light is on, then shoot.

- When the flash has fired at its maximum output and underexposure may have occurred, the ready-light on the SB-80DX blinks for approx. 3 sec. To compensate, use a wider aperture or move closer to the subject and reshoot.

◆ Setting the aperture in the Non-TTL auto flash **A** mode

- Set the aperture within the available range as shown in the table below.

Usable flash shooting distance ranges in Non-TTL auto flash and Auto Aperture flash mode

		ISO sensitivity							Zoom-head position (mm)										Flash shooting distance range (m/ft)
		1600	800	400	200	100	50	25	*1	*2	14*3	17*3	24	28	35	50	70	85	
Aperture	8	5.6	4	2.8	2	1.4		0.6-6.3/ 2.0-21	0.7-8.0/ 2.3-26	0.7-8.5/ 2.5-28	0.8-9.5/ 2.8-31	1.4-16/ 4.6-52	1.5-17/ 4.9-56	1.7-19/ 5.5-62	2.0-20/ 6.6-66	2.2-20/ 7.4-66	2.4-20/ 7.8-66	2.5-20/ 8.3-66	
	11	8	5.6	4	2.8	2	1.4	0.6-4.5/ 2.0-15	0.6-5.7/ 2.0-19	0.6-6.0/ 2.0-20	0.6-6.7/ 2.0-22	1.0-11/ 3.3-37	1.1-12/ 3.5-39	1.2-13/ 3.9-44	1.4-16/ 4.6-52	1.6-18/ 5.2-59	1.7-19/ 5.5-62	1.8-20/ 5.8-66	
	16	11	8	5.6	4	2.8	2	0.6-3.2/ 2.0-10	0.6-4.0/ 2.0-13	0.6-4.2/ 2.0-14	0.6-4.8/ 2.0-16	0.7-8.0/ 2.3-26	0.7-8.5/ 2.5-28	0.8-9.5/ 2.8-31	1.0-11/ 3.3-37	1.1-13/ 3.7-42	1.2-13/ 3.9-44	1.3-14/ 4.1-47	
	22	16	11	8	5.6	4	2.8	0.6-2.2/ 2.0-7.4	0.6-2.8/ 2.0-9.3	0.6-3.0/ 2.0-10	0.6-3.4/ 2.0-11	0.6-5.7/ 2.0-19	0.6-6.0/ 2.0-20	0.6-6.7/ 2.0-22	0.7-7.6/ 2.3-26	0.8-9.0/ 2.6-29	0.8-9.5/ 2.8-31	0.9-10/ 2.9-33	
	32	22	16	11	8	5.6	4	0.6-1.6/ 2.0-5.2	0.6-2.0/ 2.0-6.6	0.6-2.1/ 2.0-7.0	0.6-2.4/ 2.0-7.8	0.6-4.0/ 2.0-13	0.6-4.2/ 2.0-14	0.6-4.8/ 2.0-16	0.6-5.3/ 2.0-19	0.6-6.3/ 2.0-21	0.6-6.7/ 2.0-22	0.6-7.1/ 2.1-23	
	45	32	22	16	11	8	5.6	0.6-1.1/ 2.0-3.7	0.6-1.4/ 2.0-4.6	0.6-1.5/ 2.0-4.9	0.6-1.7/ 2.0-5.5	0.6-2.8/ 2.0-9.3	0.6-3.0/ 2.0-10	0.6-3.4/ 2.0-11	0.6-4.0/ 2.0-13	0.6-4.5/ 2.0-15	0.6-4.8/ 2.0-16	0.6-5.0/ 2.0-17	
	64	45	32	22	16	11	8	0.6-0.8/ 2.0-2.6	0.6-1.0/ 2.0-3.3	0.6-1.1/ 2.0-3.5	0.6-1.2/ 2.0-3.9	0.6-2.0/ 2.0-6.6	0.6-2.1/ 2.0-7.0	0.6-2.4/ 2.0-7.8	0.6-3.0/ 2.0-9.3	0.6-3.2/ 2.0-10	0.6-3.4/ 2.0-11	0.6-3.6/ 2.0-12	

*1 With the Nikon Diffusion Dome attached and the wide-flash adapter in place

*2 With the Nikon Diffusion Dome attached

*3 With the wide-flash adapter in place

- For example, for an ISO sensitivity of 100, with the zoom-head position adjusted to 35mm, and the subject at a distance of 5m (16.4 ft.), selecting apertures from f/2 to f/5.6 from the table will give the correct exposure.
- To set the aperture on Zoom-Nikkor lenses having variable maximum apertures, refer to "The flash shooting distance range with zoom lenses having a variable aperture" (p. 59).

Auto Aperture **A A** flash mode

Usable cameras and lenses **Digital SLRs + CPU lenses**

In addition to Non-TTL auto flash (p. 40), the SB-80DX's built-in sensor correctly controls the flash output in combination with data automatically transmitted from the camera and lens to the SB-80DX, including the ISO sensitivity value, aperture, focal length, and exposure compensation value.

- The Non-TTL auto flash mode is automatically set when a non-CPU lens is mounted on Digital SLRs.

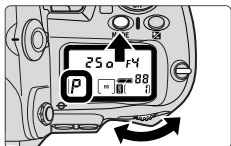

- 1** Set the camera's exposure mode to Programmed Auto (**P**) or Aperture-Priority Auto (**A**).

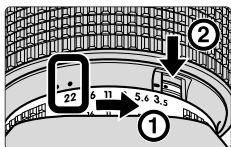

- 2** Lock the CPU lens aperture at its minimum.
 - Not necessary with a G-type lens.



- 3** Press the **MODE** button to select the **A A** (Auto Aperture flash) mode.

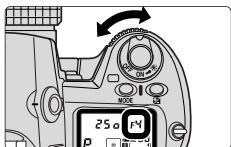

- 4** While looking at the flash shooting distance range on the SB-80DX's LCD panel, set the aperture on the camera.

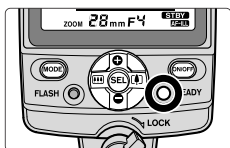

5 Compose the picture, confirm that the ready-light is on, then shoot.

- When the flash has fired at its maximum output and underexposure may have occurred, the ready-light on the SB-80DX blinks for approx. 3 sec. To compensate, use a wider aperture or move closer to the subject and reshoot.

◆ Setting the aperture in Auto Aperture \square flash mode

- Set the aperture on the camera or lens within the available range as shown in the table below.

Usable flash shooting distance ranges in the Non-TTL auto flash and Auto Aperture flash mode

		ISO sensitivity							Zoom-head position (mm)										Flash shooting distance range (m/ft)
		1600	800	400	200	100	50	25	*1	*2	14*3	17*3	24	28	35	50	70	85	
Aperture	8	5.6	4	2.8	2	1.4		0.6-6.3/ 2.0-21	0.7-8.0/ 2.3-26	0.7-8.5/ 2.5-28	0.8-9.5/ 2.8-31	1.4-16/ 4.6-52	1.5-17/ 4.9-56	1.7-19/ 5.5-62	2.0-20/ 6.6-66	2.2-20/ 7.4-66	2.4-20/ 7.8-66	2.5-20/ 8.3-66	
	11	8	5.6	4	2.8	2	1.4	0.6-4.5/ 2.0-15	0.6-5.7/ 2.0-19	0.6-6.0/ 2.0-20	0.6-6.7/ 2.0-22	1.0-11/ 3.3-37	1.1-12/ 3.5-39	1.2-13/ 3.9-44	1.4-16/ 4.6-52	1.6-18/ 5.2-59	1.7-19/ 5.5-62	1.8-20/ 5.8-66	
	16	11	8	5.6	4	2.8	2	0.6-3.2/ 2.0-10	0.6-4.0/ 2.0-13	0.6-4.2/ 2.0-14	0.6-4.8/ 2.0-16	0.7-8.0/ 2.3-26	0.7-8.5/ 2.5-28	0.8-9.5/ 2.8-31	1.0-11/ 3.3-37	1.1-13/ 3.7-42	1.2-13/ 3.9-44	1.3-14/ 4.1-47	
	22	16	11	8	5.6	4	2.8	0.6-2.2/ 2.0-7.4	0.6-2.8/ 2.0-9.3	0.6-3.0/ 2.0-10	0.6-3.4/ 2.0-11	0.6-5.7/ 2.0-19	0.6-6.0/ 2.0-20	0.6-6.7/ 2.0-22	0.7-7.6/ 2.3-26	0.8-9.0/ 2.6-29	0.8-9.5/ 2.8-31	0.9-10/ 2.9-33	
	32	22	16	11	8	5.6	4	0.6-1.6/ 2.0-5.2	0.6-2.0/ 2.0-6.6	0.6-2.1/ 2.0-7.0	0.6-2.4/ 2.0-7.8	0.6-4.0/ 2.0-13	0.6-4.2/ 2.0-14	0.6-4.8/ 2.0-16	0.6-5.3/ 2.0-19	0.6-6.3/ 2.0-21	0.6-6.7/ 2.0-22	0.6-7.1/ 2.1-23	
	45	32	22	16	11	8	5.6	0.6-1.1/ 2.0-3.7	0.6-1.4/ 2.0-4.6	0.6-1.5/ 2.0-4.9	0.6-1.7/ 2.0-5.5	0.6-2.8/ 2.0-9.3	0.6-3.0/ 2.0-10	0.6-3.4/ 2.0-11	0.6-4.0/ 2.0-13	0.6-4.5/ 2.0-15	0.6-4.8/ 2.0-16	0.6-5.0/ 2.0-17	
	64	45	32	22	16	11	8	0.6-0.8/ 2.0-2.6	0.6-1.0/ 2.0-3.3	0.6-1.1/ 2.0-3.5	0.6-1.2/ 2.0-3.9	0.6-2.0/ 2.0-6.6	0.6-2.1/ 2.0-7.0	0.6-2.4/ 2.0-7.8	0.6-2.8/ 2.0-9.3	0.6-3.2/ 2.0-10	0.6-3.4/ 2.0-11	0.6-3.6/ 2.0-12	

*1 With the Nikon Diffusion Dome attached and the wide-flash adapter in place

*2 With the Nikon Diffusion Dome attached

*3 With the wide-flash adapter in place

- For example, for an ISO sensitivity of 100, with the zoom-head position adjusted to 35mm, and subject at a distance of 5m (16.4 ft.), selecting an aperture of f/2 to f/5.6 from the table gives the correct exposure.

In this mode, the flash always fires at a specified output. The SB-80DX features three types of manual modes.

Types	Usable camera
Manual flash	No limitation
Repeating flash	No limitation
FP High-Speed Flash sync	F5, F100, F90X/N90s, F90-Series/N90, D1-Series

- You can calculate the correct aperture by using the guide number table and the shooting distance. Then set the same aperture manually on the lens. In this case, set the camera's exposure mode to Aperture-Priority Auto (A) or Manual (M).
- Refer to your camera's instruction manual for details on camera and lens aperture settings.
- If the camera's exposure mode is set to other than Aperture-Priority (A) or Manual (M) mode, the shutter may not be released, depending on the cameras in use. For details, refer to your camera's instruction manual.
- In the Manual mode, no warning ready-light blinks to indicate that the light may have been insufficient for correct exposure after shooting.

◆ Determining the aperture and flash output level in the Manual mode

- In the Manual mode, use the guide number table and the following equation to calculate the aperture, flash output level, and shooting distance to obtain the correct exposure.
- The guide number (GN at ISO 100; m/ft) indicates the amount of light generated by the flash. The larger the number, the greater the flash output.

Guide number (ISO 100, m/ft)

Flash output level	Zoom-head position (mm)										
	*1	*2	14 ³	17 ³	24	28	35	50	70	85	105
M1/1	12.5/41	16/52	17/56	19/62	32/105	34/112	38/125	44/144	50/164	53/174	56/184
M1/2	8.8/29	11.3/37	12/39	13.4/44	22.6/74	24/79	26.8/88	31/102	35/115	37.5/123	40/131
M1/4	6.3/21	8.0/26	8.5/28	9.5/31	16/52	17/56	19/62	22/72	25/82	26.5/87	28/92
M1/8	4.4/14	5.6/18	6.0/20	6.7/22	11.3/37	12/39	13.4/44	15.5/51	17.7/58	18.7/61	19.8/65
M1/16	3.1/10	4.0/13	4.3/14	4.8/16	8.0/26	8.5/28	9.5/31	11/36	12.5/41	13.3/44	14/46
M1/32	2.2/7	2.8/9	3.0/10	3.4/11	5.6/18	6.0/20	6.7/22	7.8/26	8.8/29	9.4/31	9.9/32
M1/64	1.6/5	2.0/7	2.1/7	2.4/8	4.0/13	4.3/14	4.8/16	5.5/18	6.3/21	6.6/22	7.0/23
M1/128	1.1/4	1.4/5	1.5/5	1.7/6	2.8/9	3.0/10	3.4/11	3.9/13	4.4/14	4.7/15	4.9/16
FP	-	-	-	-	10.7/35	11.3/37	12.7/42	14.7/48	16.7/55	17.7/58	18.7/61

*1 With the Diffusion Dome attached and the built-in wide-flash adapter in place

*2 With the Diffusion Dome attached

*3 With the built-in wide-flash adapter in place

To calculate the correct aperture

- Calculate the correct aperture by using this equation and the guide number table, according to the ISO sensitivity and flash output level that are set:

$$f/\text{stop (aperture)} = \text{Guide number (GN)} \times \text{ISO sensitivity factor} \div \text{Shooting distance (m/ft)}$$

- Set the same aperture on both the SB-80DX and the camera or lens.

To calculate the guide number

- Calculate the guide number by using this equation, according to the shooting distance and aperture required.

$$\text{Guide number (GN)} = \text{Shooting distance (m/ft)} \times \text{Aperture} \times \text{ISO sensitivity factor}$$

- Referring to the guide number table, determine an appropriate flash output level corresponding to the guide number obtained above, then set the same value on the SB-80DX.

ISO sensitivity factors

- For sensitivity other than ISO 100, multiply the guide number at an ISO sensitivity of 100 by the factors shown in the guide number table.

ISO	25	50	100	200	400	800	1600
Factors	x0.5	x0.71	x1	x1.4	x2	x2.8	x4

◆ Manual flash operation

- In Manual flash photography, you select the aperture and flash output level. In this way, you can control the exposure and flash shooting distance when shooting subjects where the correct exposure is difficult to obtain in the TTL or Non-TTL auto flash mode. In Manual flash operation, the flash output level can be set from M1/1 to M1/128 to match your creative preferences.

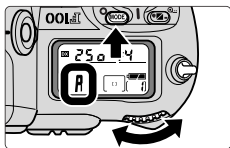

- 1** Set the camera's exposure mode to Aperture-Priority Auto (**A**) or Manual (**M**).

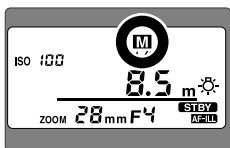

- 2** Press the **(MODE)** button until "**M**" appears on the LCD panel.

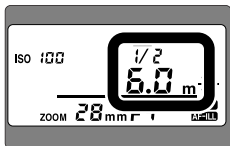

- 3** Determine the flash output level and aperture to match the flash shooting distance. Then set the flash output level and the aperture on the SB-80DX.
 - For details on determining the flash output level and the aperture, refer to "Determining the aperture and flash output level in the Manual mode" (p. 44).
 - For setting the flash output level, refer to "Setting the flash output level" (p. 47).
 - If the ISO sensitivity is correctly set, the flash shooting distance appears on the LCD panel, matching the flash output level and aperture as set.

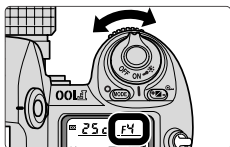

- 4** Set the same aperture on your camera or lens that is set on the SB-80DX.
 - For cameras in Groups I and II, and Digital SLRs cameras with CPU lenses, set the SB-80DX's aperture on the camera (p. 4).

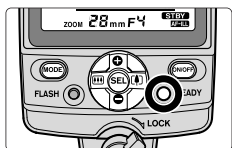

- 5** Confirm that the ready-light is on, then shoot.

Setting the flash output level

- The flash output level changes every time you press the **-** or **+** button as shown below.

When you press the **-** button:

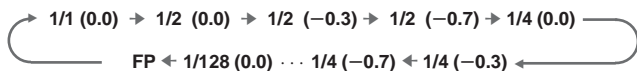

When you press the **+** button:

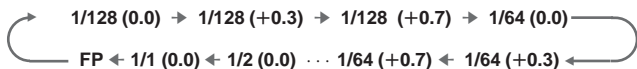

- The numbers in parentheses represent the adjustable flash output level in $\pm 1/3$ steps except between $1/1$ and $1/2$. Therefore, $1/32 (-0.3)$ and $1/64 (+0.7)$ represent the same flash output level.
- FP** indicates FP High-Speed Flash sync (p. 51). This indicator appears only when the SB-80DX is used in combination with cameras compatible with FP High-Speed Flash sync.
- To extend the flash shooting distance, choose a flash output level close to M1/1.

◆ Repeating flash mode

- In the Repeating Flash mode, the SB-80DX fires repeatedly during a single exposure, creating stroboscopic multiple-exposure effects. This mode is useful when shooting fast-moving subjects.
- In the Repeating flash mode, use fresh or fully charged batteries. Also allow enough time for the flash to recycle between each repeating flash.
- In the Repeating flash mode, use a tripod to prevent camera/flash shake, because slower shutter speeds are used.

Setting the flash output level, the frequency (Hz), and the number of repeating flashes per frame

- Frequency (Hz) represents the number of times the flash fires per second.
- The actual number of repeating flashes per frame becomes lower than the one set as the shutter speed increases or the number of flashes per second decreases, because the Speedlight fires during a single exposure.
- Referring to the table below, set the flash output level, the frequency, and the number of repeating flashes separately for each picture.

Maximum number of repeating flashes per frame

Frequency*	Flash output level				
	1/8	1/16	1/32	1/64	1/128
1-2 Hz	14	30	60	90	90
3 Hz	12	30	60	90	90
4 Hz	10	20	50	80	80
5 Hz	8	20	40	70	70
6 Hz	6	20	32	56	56
7 Hz	6	20	28	44	44
8 Hz	5	10	24	36	36
9 Hz	5	10	22	32	32
10 Hz	4	8	20	28	28
20-100 Hz	4	8	12	24	24

* Frequency (Hz) represents the number of flashes per second.

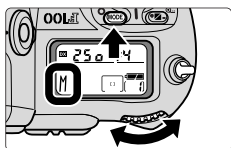

1 Set the camera's exposure mode to Manual (M).

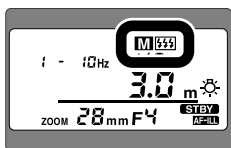

2 Press the **(MODE)** button to set the flash mode to the **(---)** Repeating Flash mode.

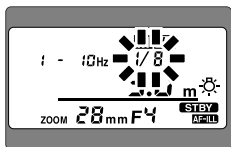

3 Press the **(SEL)** button and the flash output level starts blinking. Press the **(+)** or **(-)** button to increase or decrease the values.
 • The flash output level blinks during adjustment and stops after 8 seconds unless an adjustment is made. The last blinking number is the one automatically set.

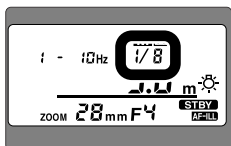

4 Press the **(SEL)** button and the flash output level stops blinking.
 • After that, the frequency starts blinking.

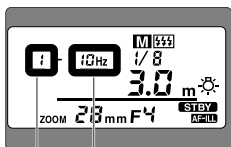

5 Repeat the procedures above to set the frequency and the number of repeating flashes per frame.

Frequency (Hz)

Number of repeating flashes per frame

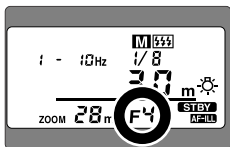

- 6** Determine the guide number according to the flash output level and zoom-head position set, then calculate the correct aperture from the guide number and the shooting distance. Finally set this aperture on the SB-80DX.

- Refer to “Guide number table” (p. 45) and “Determining the aperture and flash output level in the Manual mode” (p. 44).
- If the ISO sensitivity is set correctly, the flash shooting distance appears on the LCD panel to match to the flash output level and aperture as set.

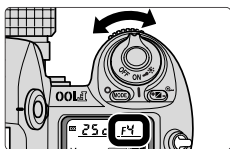

- 7** Set the same aperture on the camera or lens that is set on the SB-80DX.

- For cameras in Groups I and II, and Digital SLRs cameras with CPU lenses, set the SB-80DX's aperture on the camera (p. 4).

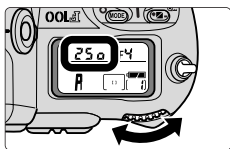

- 8** Set the shutter speed.

- Use the equation to determine the shutter speed and set that shutter speed or one slower.

$$\text{Shutter speed} = \frac{\text{Number of flashes per frame}}{\text{Frequency of flashes (Hz)}}$$

- For example, if the number of flashes per frame is 10 and frequency is 5 Hz, divide 10 by 5 to get a shutter speed of 2 sec. or slower.
- Or you can set the shutter speed to **B** (bulb) to accommodate any number of repeating flashes.

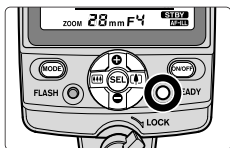

- 9** Confirm that the ready-light is on, then shoot.

Making sure the flash fires correctly before shooting

- Press the **FLASH** button to make sure the flash fires correctly as set.

Exposure compensation in the Repeating flash mode

- The flash shooting distance calculated in step number 6 is the correct exposure for the first flash in the sequence. Therefore, repeating flash at this flash output level will result in overexposure of any overlapping images. To prevent this, set a smaller aperture on the camera.

◆FP High-Speed Flash sync **FP** mode

Usable cameras F5, F100, F90X / N90s, F90-Series / N90, D1-Series

- High-speed flash synchronization at shutter speeds between 1/250 and 1/4000 sec. (1/500 and 1/16000 sec. for the D1-Series) is possible, allowing you to use a wider aperture to achieve shallow depth of field and blur the background.
- Do not use the built-in wide-flash adapter (p. 72) or Nikon Diffusion Dome (p. 69). When the wide-flash adapter is used, the zoom-head position and **FP** indicator blink on the LCD panel as a warning.
- When you remove the SB-80DX from the camera, be sure to cancel FP flash operation so that **FP** disappears. If the flash unit is removed with the FP setting, **FP** blinks as a warning.

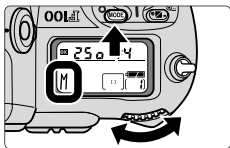

- 1 Set the camera's exposure mode to Manual (**M**).

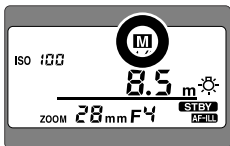

- 2 Press the **(MODE)** button until "**M**" appears on the LCD panel.

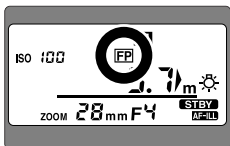

- 3 Press the **+** or **-** button until "**FP**" appears on the LCD panel.

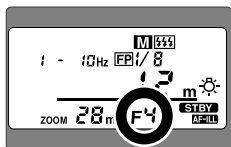

4 Determine the aperture and flash output level to match the main subject's shooting distance. Set the same aperture and flash output level on the SB-80DX.

- For details on calculating the flash output level and aperture, refer to "Determining the aperture and flash output level in the Manual mode" on page p. 44 and "Guide number table" on p. 45.
- For setting the flash output level, refer to "Setting the flash output level" on page 47.
- For cameras in Groups I and II, and Digital SLRs cameras with CPU lenses, set the SB-80DX's aperture on the camera (p. 4).
- If ISO sensitivity is correctly set, the flash shooting distance appears on the LCD panel to match to the flash output level and aperture as set.

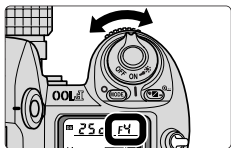

5 Set the same aperture on your camera or lens that is set on the SB-80DX.

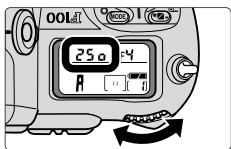

6 Set the shutter speed between 1/250 and 1/4000 sec. (between 1/500 and 1/16000 sec. for the D1-Series).

- Setting a shutter speed slower than 1/250 sec. is not recommended.
- The faster the shutter speed, the smaller the flashoutput (guide number).

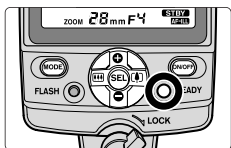

7 Confirm that the ready-light is on, then shoot.

Notes on continuous flash shooting

◆ Maximum number of continuous firings

- It is recommended to allow the SB-80DX to cool off for at least 10 minutes after the maximum number of continuous firings as shown in this table:

Max. no. of continuous firings

Flash mode	Max. no. of continuous firings (at 6 frames/sec.)
TTL/D-TTL auto flash Non-TTL auto flash/Auto Aperture flash Manual flash (Flash output level: M1/1, M1/2)	15
Manual flash (Flash output level: M1/4 to M1/128)	40

Detailed operation

◆ Synchronization during continuous flash shooting

- It is possible to take up to the number of frames during continuous shooting as shown in the table below. However, if the continuous firings exceed the maximum numbers as shown in the table above, you should allow the SB-80DX to cool off for at least 10 minutes.

Maximum number of frames during continuous flash shooting (at six frames per sec.)

Optional power source	Batteries inside SB-80DX	Flash output level				
		1/8	1/16	1/32	1/64	1/128
SB-80DX only	All types	Up to 4	Up to 8	Up to 16	Up to 30	Up to 40
SD-7	Alkaline-manganese	Up to 6	Up to 10	Up to 40	Up to 40	Up to 40
SD-8A	Alkaline-manganese	Up to 5	Up to 10	Up to 20	Up to 40	Up to 40
	Lithium			Up to 30		
	NiCd	Up to 5	Up to 10	Up to 30	Up to 40	Up to 40
	Ni-MH					
SK-6A	Alkaline-manganese	Up to 5	Up to 10	Up to 20	Up to 40	Up to 40
	Lithium					
	NiCd	Up to 5	Up to 10	Up to 30	Up to 40	Up to 40
	Ni-MH					

- With fresh batteries of the same type in both the SB-80DX and optional Nikon SD-8A or Power Bracket Unit SK-6A.
- Refer to table "Maximum number of repeating flashes per frame" on page 48 when performing Repeating flash.

Checking the correct exposure before shooting

You can determine whether the subject will receive the correct exposure by test firing the SB-80DX before actually taking the picture.

◆ TTL auto flash mode

- Press the SB-80DX's MODE button until "A" (Non-TTL auto flash) appears on the LCD panel. Set the same aperture on the SB-80DX as set in the TTL auto flash mode. Press the **FLASH** button to fire the flash. If the ready-light blinks after firing, this indicates the light may have been insufficient for correct exposure. In this case, set a wider aperture on the camera or lens, or move closer to the subject.

◆ D-TTL auto flash mode

- Press the SB-80DX's MODE button until "AA" (Auto Aperture flash) appears on the LCD panel. Set the same aperture on the SB-80DX as set in the D-TTL auto flash mode. Press the **FLASH** button to fire the flash. If the ready-light blinks after firing, this indicates the light may have been insufficient for correct exposure. In this case, set a wider aperture on the camera or lens, or move closer to the subject.

◆ Non-TTL auto flash mode

- Make the necessary settings on the SB-80DX and camera, and press the **FLASH** button. If the ready-light blinks after firing, this indicates the light may have been insufficient for correct exposure. In this case, set a wider aperture on the camera or lens, or move closer to the subject.

◆ Auto Aperture flash mode

- Make the necessary settings on the SB-80DX and camera, and press the shutter release button slightly, then press the **FLASH** button. If the ready-light blinks after firing, this indicates the light may have been insufficient for correct exposure. In this case, set a wider aperture on the camera or lens, or move closer to the subject.

◆ Manual flash mode

- In manual flash mode, checking the correct exposure cannot be performed by test firing. Calculate the correct flash output level, aperture, and flash shooting distance by referring to "Determining the aperture and flash output level in the Manual mode" (p. 44).

Advanced operation

In this section advanced information on each function of the SB-80DX's is provided.

Exposure compensation and flash output level

Exposure compensation allows you to take well-balanced pictures by intentionally modifying the correct exposure when a subject of extremely high or low reflectivity is included in a picture or when you want to create flash photographs to match your creative preferences.

- Some plus compensation may be necessary when the background includes a mirror, white wall, or other highly reflective surface. Likewise, some minus compensation may be required when the background is dark or includes subjects of low reflectivity.
- Making exposure compensation for both the main subject and background or the main subject without affecting the background are possible, depending on the flash shooting situations.

Exposure compensation on the SB-80DX can be performed in the following ways:

Exposure compensation	Available flash mode	Usable camera
Making exposure compensation for both the main subject and background	All flash modes	Cameras in all groups
Making exposure compensation for the main subject only	TTL/D-TTL auto flash and Auto Aperture flash	Cameras in groups I to III, and Digital SLRs
	Manual flash mode	Cameras in all groups
Making exposure compensation for the background only	Flash shooting at slow shutter speeds	Cameras in all groups

◆ Making exposure compensation for both the main subject and background

In TTL/D-TTL auto flash and Auto Aperture flash

- Use the camera's exposure compensation function to modify both the SB-80DX's flash output level and the background exposure. For details, see your camera's instruction manual.
- The exposure compensation value set on the camera is not displayed on the SB-80DX's LCD panel.
- Exposure compensation beyond the usable ISO sensitivity range cannot be performed (p. 23). For example, with an ISO sensitivity of 100, if you try to make an exposure compensation of +3 steps on the camera (equivalent to ISO 12), which is out of the usable ISO sensitivity range (ISO 25-1000) of the SB-80DX. However, exposure compensation up to +2 steps (equivalent to ISO 25) is possible.

Making exposure compensation in the Non-TTL auto flash and Manual flash mode

- Exposure compensation is performed by intentionally modifying the correct aperture.
- In the Non-TTL auto flash mode, the correct exposure can be obtained when the same aperture is set on the camera as that set on the SB-80DX. Therefore, to make exposure compensation, vary the aperture set on the camera while retaining the aperture set on the SB-80DX or vice versa.
- In the Manual flash mode, calculate the proper aperture for the correct exposure from the guide number and the shooting distance (p. 45). Then referring to this aperture, modify the aperture on the camera to make exposure compensation.
- As a basic guide, set a wider aperture on the camera or lens to make the subject brighter or a smaller aperture to make it darker.

◆ Making exposure compensation for the main subject only

In TTL/D-TTL auto flash and Auto Aperture flash

- Making exposure compensation for a flash illuminated subject without affecting the background exposure is called flash output level compensation (p. 58).
- This compensation is performed with cameras in Groups I to III and Digital SLRs cameras.

In Manual flash mode

- Making exposure compensation for only the flash illuminated subject by intentionally modifying the SB-80DX's flash output level (M1/1 to M1/128). For cameras in all groups.

◆ Making exposure compensation for the background only

- Set the camera's exposure mode to Shutter-Priority Auto (**S**) or Manual (**M**), and set the shutter speed to one slower than its flash sync shutter speed.
- With cameras providing slow-sync, set the camera's flash sync mode to Slow-sync (p. 60) to bring out background details in low-light situations.
- For details, see your camera's instruction manual.

◆ Flash output level compensation

Usable cameras For cameras in Groups I to III, and Digital SLRs cameras

- Make exposure compensation for a flash illuminated subject without affecting the background exposure by modifying the SB-80DX's flash output level.
- Available in the TTL/D-TTL auto flash and Auto Aperture flash modes.
- With cameras in Group III, make flash output level compensation on the camera. Flash output level compensation cannot be made on the SB-80DX. The amount of compensation set on the camera does not appear on the SB-80DX's LCD panel. For details, see your camera's instruction manual.

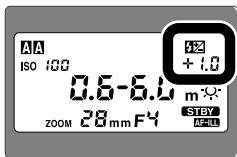

- 1 Press the button, or the or button, to display the Exposure compensation indicator, and the Flash output level compensation value starts blinking.

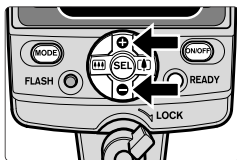

- 2 Press the or button to increase or decrease the compensation in 1/3 steps (or in 1/6 steps with Digital SLRs) from -3.0 to +3.0 EV.
- 3 Press the button and the flash output level compensation value stops blinking.
 - The flash output level blinks during adjustment and stops after 8 seconds unless an adjustment is made. The last blinking number is the one automatically set.

- With F80-Series/N80-Series, F70-Series/N70, and Pronea 600i/6i cameras having an exposure compensation function, you can compensate the flash output level on either the camera or SB-80DX. For details, see your camera's instruction manual. If you use both controls, the exposure is modified by the sum total of both compensation values. In this case, the SB-80DX's LCD panel shows only the compensation value set on the SB-80DX.

Canceling flash output level compensation

The flash output level compensation cannot be canceled by turning the SB-80DX off. To cancel, press the or button to set the compensation value back to 0.0 and make sure the exposure compensation indicator disappears.

With zoom lenses having a variable aperture, take note of the following before setting the aperture on the SB-80DX and confirming the flash shooting distance range.

Lenses having a variable aperture

- There are two maximum aperture values indicated in the lens model name. For example with the AF Zoom-Nikkor 28-105mm f/3.5-4.5D IF, the maximum aperture at 28mm is f/3.5, but decreases to f/4.5 at 105mm.

◆ Reading the aperture on the camera's LCD panel or in the viewfinder

- After composing the picture by zooming in or out, read the aperture on the camera's LCD panel or in the viewfinder. Then set the same aperture on the SB-80DX's LCD panel and confirm the flash shooting distance range.
- Aperture values are automatically compensated by the camera and appear on the camera's LCD panel or in the viewfinder. The aperture value displayed in the aperture-direct-readout scale as seen in the viewfinder of the Nikon F5 or other cameras is fixed and not automatically compensated.

◆ Reading the aperture using the scale on the lens

- After zooming in or out to select the appropriate composition, read the aperture using the aperture scale on the lens. Then set the same aperture on the SB-80DX's LCD panel and confirm the flash shooting distance range.
 - At wideangle zoom settings, read the aperture value at the green index (or line).
 - At telephoto settings, read the aperture value at the yellow index (or dot).
 - At intermediate settings, read the aperture value between the two indexes.

◆ Reading the aperture using the camera's aperture dial

F-401x/N5005, F-401s/N4004s, F-401/N4004 camera + **CPU lens**

- After zooming in/out to select the desired composition, read the aperture using the camera's aperture dial. Then set the same aperture on the SB-80DX's LCD panel and confirm the flash shooting distance range.
- Set the camera's exposure mode to Aperture-Priority Auto (**A**) or Manual (**M**). The aperture value set on the lens cannot be confirmed in the Programmed Auto (**P**) or Shutter-Priority Auto (**S**) exposure mode.
- For cameras having TTL metering, the aperture on zoom lenses is automatically compensated by the camera.
- In case of setting a larger or smaller value than the lens aperture on the camera's aperture dial, set the lens' maximum or minimum aperture on the SB-80DX.

Slow-sync flash mode/Red-eye reduction control

◆ Slow-sync flash

- The flash is controlled at a slow shutter speed to obtain the correct exposure for both the main subject and background in low-light situations or at night.
- Available with cameras providing slow-sync. You cannot set the slow-sync function on the SB-80DX directly. Set it on the camera. For more information, refer to your camera's instruction manual.
- Since slow shutter speeds are usually used, use a tripod to prevent camera shake.

◆ Red-eye reduction

- To prevent the center of your subject's eyes from appearing red in color pictures, the SB-80DX's red-eye reduction lamp lights up for approx. 1 sec. before the picture is taken.
- Available with cameras having red-eye reduction control. You cannot set red-eye reduction on the SB-80DX directly. Set it on the camera. For more information, refer to your camera's instruction manual.
- After setting your camera to red-eye reduction, make sure that "👁" appears on the SB-80DX's LCD panel.



◆ Red-eye reduction with slow-sync flash mode

- In this mode, red-eye reduction is combined with slow sync.
- Available with cameras having red-eye reduction with slow-sync. You cannot set this mode on the SB-80DX directly. Set it on the camera. For more information, refer to your camera's instruction manual.
- After setting your camera to red-eye reduction with slow sync, make sure that "👁" appears on the SB-80DX's LCD panel.
- Since slow shutter speeds are usually used, use a tripod to prevent camera shake.

Rear-curtain sync and Modeling illumination

◆Rear-curtain sync



Rear-curtain sync



Front-curtain sync

Shooting data

- Camera: F100 (2 seconds, $f/4 + 1/2$)
- Focal length: 70mm
- Speedlight: SB-80DX (Manual, flash output level: M1/1)
- In normal flash synchronization, when shooting fast-moving subjects at slow shutter speeds, this usually results in unnatural-looking pictures where the subject frozen by the flash appears behind or within the blurred movement. Rear-curtain flash sync creates a picture in which the blur of a moving subject (for example, the taillights of a car) appears behind the subject and not in front.
- Available with cameras providing rear-curtain sync. You cannot set this mode on the SB-80DX directly. Set it on the camera. For details, see your camera's instruction manual.
- Since slow shutter speeds are usually used, use a tripod to prevent camera shake.
- This function does not operate in either the FP High-Speed flash sync or Repeating flash mode.
- In multiple flash, the master flash unit can be set to either front-curtain or rear-curtain sync flash. The slave units cannot be set to rear-curtain sync flash (p. 74).

◆Modeling illumination

Usable cameras	All cameras
-----------------------	--------------------

- Press the Modeling illuminator button and the modeling illuminator lights up (or the flash fires) repeatedly at a reduced flash output level. This is useful for checking the illumination and the shadows cast on the subject before actually taking the picture.

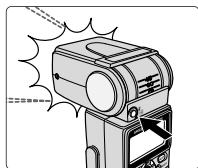

- The modeling illuminator lights up for a maximum of approx. 3 sec. while the modeling illuminator button is pressed.
- The modeling illuminator can be set to operate only after the ready-light comes on.
- The modeling illuminator will not light up in the wireless slave flash mode (p. 84).

Autofocus flash operation in dim light

Usable cameras and lenses **Cameras with autofocus function + autofocus lens**

When the light is too dim for normal autofocus operation, the SB-80DX's AF-Assist Illuminator enables you to perform autofocus flash photography in dim light.

In dim light, the AF-assist illuminator turns on automatically when the camera's shutter release button is lightly pressed if an AF lens is mounted and the camera's focus mode is set to S (Single Servo AF with focus priority), AF, or A.

- The effective shooting distance with the AF-assist illuminator is approx. 1m to 10m with a 50mm f/1.8 lens or shorter, depending on the lens in use.
- Usable lens focal length: 24mm to 105mm (35 to 105mm for F-501/N2020 cameras)
- The AF-Assist Illuminator is activated when **AF-ILL** appears on the LCD panel.
The AF-Assist Illuminator is canceled when **NO AF-ILL** appears on the LCD panel.
- The AF-Assist Illuminator is set to activate when shipped from the factory.

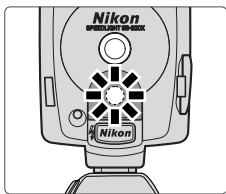

- If the focus indicator does not appear in the camera's viewfinder even through the AF-Assist Illuminator turns on, focus manually.
- Refer to your camera's instruction manual.

The AF-Assist Illuminator will not light up, if:

- The autofocus is locked or the ready-light does not come on.
- The camera's center focus area is not selected with cameras having Focus Area selection. For details, refer to your camera's instruction manual.

◆For cameras having a built-in Speedlight

- Even when the camera's AF-Assist Illuminator is set to activate, the SB-80DX's AF-Assist Illuminator is given priority and the camera's AF-Assist illuminator does not light up. (The camera's AF-Assist Illuminator lights up when the SB-80DX's AF-Assist Illuminator is canceled.)
- With F60-Series/N60 cameras, the AF-Assist Illuminator lights up while shooting at full-output manual.
- With F80-Series/N80-Series, and F65-Series/N65-Series cameras, the camera's AF-Assist Illuminator lights up when the SB-80DX's AF-Assist illuminator is canceled. To cancel the camera's AF-Assist Illuminator, cancel it on the camera. For details, refer to your camera's instruction manual.

◆Activating and canceling the AF-Assist illuminator using Custom settings

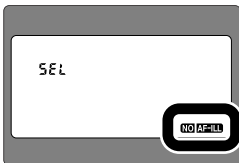

- 1 Press the **SEL** button for more than 2 sec. to display the Custom settings mode.
- 2 Press the **+** or **-** button to choose "AF-Assist illuminator."
- 3 Press the **AF-ILL** or **NO AF-ILL** button to activate or cancel the AF-Assist Illuminator:
AF-ILL: Activate
NO AF-ILL: Cancel
- 4 Press the **SEL** button for more than 2 sec. or press the **ON/OFF** button to return to the normal setting mode.

- When the AF-Assist Illuminator is canceled, autofocus operation may not be performed in dim light.

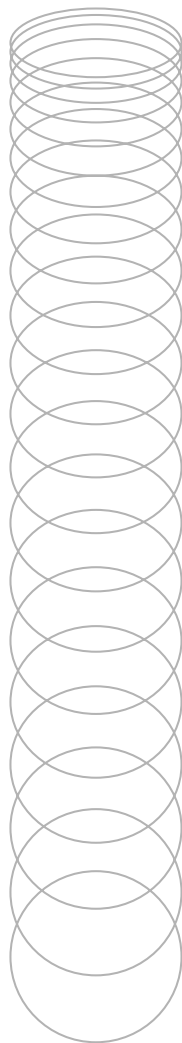

Technical operation/ Effective Speedlight placement

In this section, information on a variety of photographic techniques such as bounce and close-up flash is provided, explaining how to create flash pictures with softer shadows.

We also present the recommended position of Speedlights in wireless multiple flash photography or when attached with cords.

Bounce flash operation (For taking pictures without

Tilt or rotate the flash head to bounce the light off the ceiling or walls to soften shadows and create more natural-looking portraits indoors. Even softer shadows are possible when using the Nikon Diffusion Dome.



Bounce flash



Normal flash

Shooting data:

- Camera: F100
- Focal length: 70mm
- Speedlight: SB-80DX set to Standard TTL flash
- Aperture: f/5.6 +1/3
- Shooting distance: 3m (9.8 ft.)

Shooting data:

- Camera: F100
- Focal length: 70mm
- Speedlight: SB-80DX set to Standard TTL flash
- Aperture: f/11 +1/3
- Shooting distance: 3m (9.8 ft.)

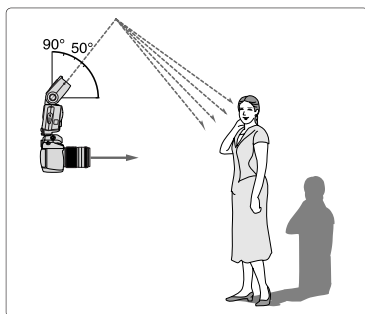

Tilting the flash head

- Tilt the flash head up at least 50° to bounce light off the ceiling for effective bounce flash. Make sure that the light from the flash head does not directly illuminate the subject.
- Optimum results are obtained when the flash head is positioned 1 to 2m (3.3 to 6.6 ft.) away from the reflecting surface.

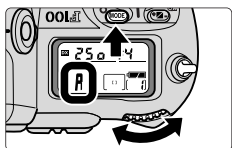

- 1** Set the camera's exposure mode to Aperture-Priority Auto (**A**) or Manual (**M**).

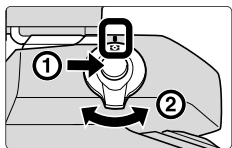

- 2** Set the camera's metering system to Matrix Metering  or Center-Weighted Metering .



- 3** Set the flash mode to TTL/D-TTL auto flash, or Non-TTL auto/Auto Aperture flash.

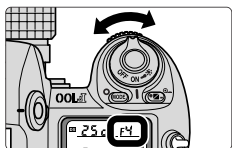

- 4** Set the camera's aperture.
• Refer to page 68 for setting the aperture.

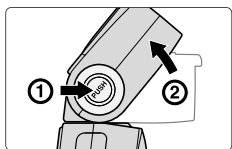

- 5** Adjust the flash head.

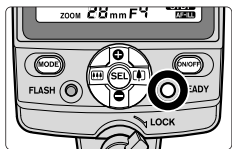

- 6** Make sure that the ready-light is on, then shoot.
• When the flash has fired at its maximum output and underexposure may have occurred, the ready-light on the SB-80DX blinks for approx. 3 sec. To compensate, use a wider aperture or move closer to the subject and reshoot.

Bounce flash operation

◆ Setting the aperture

- With bounce flash, there is a light loss when compared with normal flash with the flash head adjusted to the horizontal/front position. You should use an aperture that is 2 to 3 stops wider.
- The flash shooting distance range indicator disappears, if the flash head is adjusted to other than the horizontal/front position. First, confirm the flash shooting distance range and aperture at the horizontal/front position, then set the aperture on the camera.
- In the Non-TTL auto flash mode, set the same aperture on the SB-80DX.

◆ Setting the flash head

- The SB-80DX's flash head tilts or rotates by holding down the flash head tilting/rotating lock release button as shown in the illustrations. Adjust the flash head, depending on the shooting environment or your creative preferences.

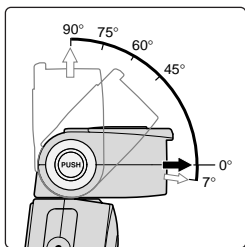

Flash head tilting and rotating angles

- The SB-80DX's flash head tilts up 90° and rotates horizontally 180° to the left and 90° to the right.
- Set the flash head at a click stop at the angles shown.
- When taking close-up pictures with flash, tilt the flash head down to the -7° position (p. 70).

Choosing the reflecting surface

- In color photography, select white or highly reflective surfaces to bounce the light off. Otherwise, your pictures will come out with an unnatural color cast similar to that of the reflecting surface.

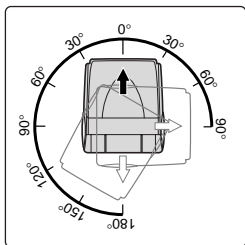

◆ Using the built-in bounce card

- In bounce flash photography, use the SB-80DX's built-in bounce card to create a highlight in the subject's eyes, making the eyes look more vibrant.
- As shown in the illustrations below, pull out the wide-flash adapter. While holding the bounce card, slide the wide-flash adapter back into place inside the flash head.
- Tilt the flash head up 90° to use this function most effectively.

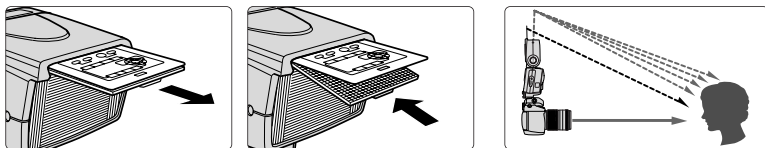

◆ Shooting with the Nikon Diffusion Dome

- Use of the provided Nikon Diffusion Dome diffuses the light from the flash much more than with normal bounce flash, allowing you to soften the light from the flash and eliminate shadows. With the camera in the vertical position, the Nikon Diffusion Dome provides the same effect.
- Good results are generally obtained when the flash head is tilted up 60°.
- Use of the built-in wide-flash adapter in conjunction with the the Nikon Diffusion Dome results in much more diffused light (p. 72).

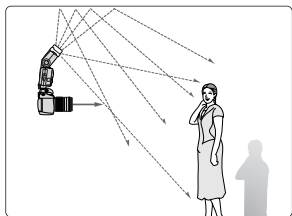

Nikon Diffusion Dome attached

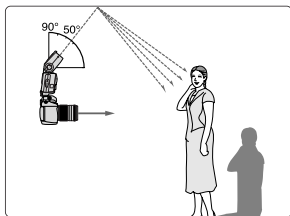

Nikon Diffusion Dome not attached

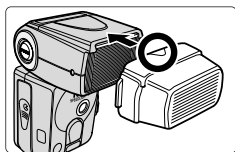

- Attach the Nikon Diffusion Dome as shown in the illustration.
- The zoom-head position is automatically set at 14mm.

Close-up flash operation

With the built-in wide-flash adapter attached to the SB-80DX, close-up flash shooting can be performed. The built-in wide-flash adapter diffuses the light from the flash to soften shadows. When the SB-80DX is used off-camera, you can take more natural-looking close-up pictures.

- Be sure to use the wide-flash adapter when taking close-up flash photographs.
- Take care that light from the flash is not obstructed by the lens barrel when a long lens is used.
- Vignetting due to the lighting situation, lens in use, focal length, etc. may occur in close-up flash shooting. It is strongly recommended to make test shots before taking the final pictures.



Flash shooting with two flash units



Flash shooting with one flash unit

Shooting data:

- Camera: F100
- Focal length: 105mm
- Speedlight: Two SB-80DX units set to Standard TTL flash
- Aperture: $f/22 + 2/3$
- Shooting distance: 50cm (20 in.)
- ISO sensitivity: 100

Shooting data:

- Camera: F100
- Focal length: 105mm
- Speedlight: Single SB-80DX unit set to Standard TTL flash
- Aperture: $f/16$
- Shooting distance: 50cm (20 in.)
- ISO sensitivity: 100

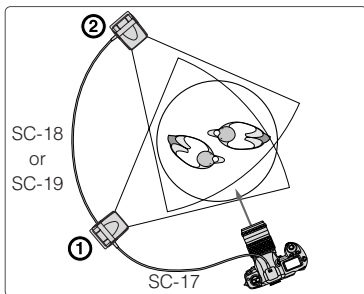

An example of close-up shooting with two flash units

The subject is illuminated from behind by flash unit ② to emphasize the small subject's contours, while flash unit ① is used off-camera to illuminate the subject from the side, softening the shadows.

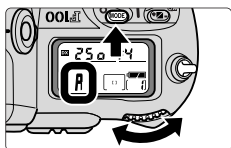

- 1** Set the camera's exposure mode to Aperture-Priority Auto (**A**) or Manual (**M**).

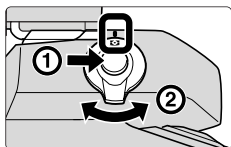



- 2** Set the camera's metering system to Matrix Metering  or Center-Weighted Metering .

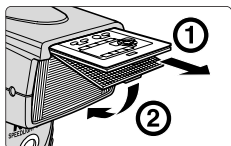

- 3** Set the SB-80DX's flash mode to TTL or D-TTL auto flash.



- 4** Position the built-in wide-flash adapter over the flash head. Press the  or  button to adjust the zoom-head position to 14mm or 17mm.

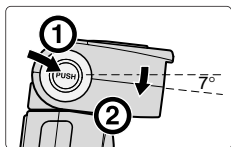

- 5** Tilt the flash head down to -7° .
- This position is recommended to illuminate the lower portion of the subject sufficiently in close-up photography when the SB-80DX is attached to the camera and used as the only flash unit.
 - The underbar blinks when the flash head is tilted down to this position.

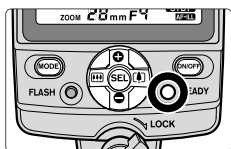

- 6** Confirm that the ready-light is on, then shoot.
- When the flash has fired at its maximum output and underexposure may have occurred, the ready-light on the SB-80DX blinks for approx. 3 sec. To compensate, use a wider aperture or move closer to the subject and reshoot.

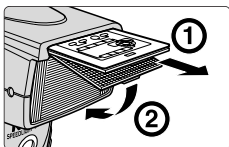

Close-up flash operation

◆ Setting the built-in wide-flash adapter and adjusting the zoom-head position



1 Slowly pull out the wide-flash adapter all the way, and position it over the flash head. Then slide the bounce card back into place inside the flash head.



2 Press the  or  button to adjust the zoom-head position to 14mm or 17mm.

- When the wide-flash adapter is set on the flash head, the power zoom function becomes inactive and the zoom-head position is adjusted to 14mm or 17mm.
- To slide the wide-flash adapter back into place, raise it and push it into the flash head as far as it will go.

◆ Setting the aperture

- Calculate the aperture by using this equation and table. Setting a smaller aperture than the one obtained from the equation is recommended.

ISO sensitivity	25	50	100	200	400	800	1000
Coefficient (m/ft)	1.4/4.6	2/6.6	2/6.6	4/13	4/13	5.6/18	5.6/18

$$f/\text{stop} \geq \text{Coefficient} \div \text{Flash-to-subject distance}$$

- For example, with a subject 0.5m (1.6 ft) away using an ISO sensitivity of 100 and with the wide-flash adapter in place, the suggested aperture is:

$$f/\text{stop} \geq 2 \div 0.5 = 4 \text{ (in meters)}$$

$$f/\text{stop} \geq 6.6 \div 1.6 = \text{approx. } 4 \text{ (in feet)}$$

Therefore, you should use at least f/4 or an even smaller aperture, such as f/5.6 or f/8.

◆ When shooting subjects closer than 0.6m (2 ft)

- With the SB-80DX attached to the camera, sufficient illumination of the subject cannot be obtained. In this case, use the SB-80DX off-camera by attaching the optional TTL Remote Cord as shown below.

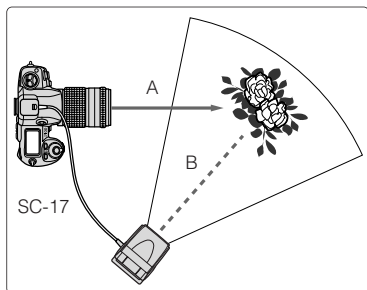

- For cameras in Group I in 3D Multi-Sensor Balanced Fill-Flash and Digital SLRs cameras in 3D Multi-Sensor Balanced Fill-Flash for Digital SLRs, you may not be able to obtain correct exposure, because distance information from the lens is used. In this case, position the camera (A) and the SB-80DX (B) at equal distances from the subject.
- For F5 cameras with the High-Magnification Finder DW-30 or DW-31, or F4 cameras with the High-Magnification Finder DW-20 or DW-21, use the optional TTL Remote Cord SC-24 instead of the SC-17.

Multiple flash operation (Creating various flash

Multiple flash photography allows you to create more natural-looking pictures by using several flash units to eliminate the shadows cast by the subject or to emphasize the subject's shape. Multiple flash operation can be performed in two ways: (1) By using cords or (2) Wireless operation.

◆ Notes on performing multiple flash (common to both operations)

- Be sure to read the instruction manuals of your camera and the Speedlight(s) in use.

Master flash unit and slave flash unit(s)

- In this manual, the flash unit mounted on the camera or the one directly connected to the camera using a remote cord is called the master flash unit. All other flash units are called slave flash units.

Canceling Monitor Preflashes in multiple flash operation

- Cancel the Monitor preflashes of the master flash unit following either one of the methods described below, since Monitor Preflashes cause incorrect exposure.

SB-80DX/SB-50DX	<ol style="list-style-type: none">1 Set to the wireless flash mode.2 Set the flash mode to Standard TTL flash.3 Tilt the flash head up.4 Use a non-CPU lens.
SB-28/28DX, SB-27, SB-26, SB-25	<ol style="list-style-type: none">1 Set the flash mode to Standard TTL flash.2 Tilt the flash head up.3 Use a non-CPU lens.
Built-in Speedlight (F80-Series/N80-Series, F70-Series/N70)	Set the exposure mode to Manual.

Multiple flash with Nikon Digital SLRs cameras

- Because Monitor Preflashes are fired at all times in the D-TTL auto flash mode, Digital SLRs cameras cannot be used for multiple flash shooting in this mode.
- With Digital SLRs cameras, only manual multiple flash operation is possible in multiple flash shooting using cords. In wireless multiple flash shooting, set the master flash unit's flash mode to the Auto Aperture (**AA**) or Non-TTL auto flash (**A**) mode.

Manual multiple flash mode

- FP High-Speed Flash sync and Repeating flash are not possible.

Canceling the power standby function

- When using a Speedlight having a standby function as a slave flash unit, make sure that the standby function is set to off, or select a standby duration that is long enough, using the Custom settings mode.
- The SB-80DX's standby function is canceled while the SB-50DX's standby duration is prolonged to approx. one hour when they are set to the wireless slave flash mode.

Turn off the power

- Turn off the camera and all the flash units before mounting the master flash unit on the camera or connecting the master flash unit to the slave flash units.

Setting the angle of coverage of the slave flash units

- Set the angle of coverage of the slave flash units wider than the picture angle, so that the subject will receive sufficient illumination even when the angle of the flash head is off axis from the subject. Remember, the closer the subject, the wider the angle of coverage required.

Compound guide number

- You can calculate the compound guide number (GN) by using the following equation when more than one Speedlight is used in Manual multiple flash operation.

$$GN = \sqrt{(\text{GN of Speedlight A})^2 + (\text{GN of Speedlight B})^2 + \dots}$$

Balancing the illumination when using more than one Speedlight

- The brightness of the flash illumination is inversely proportional to the square of the distance between the flash unit and the subject. For example, if the distance between Speedlight A and the subject is 1m (3.3 ft.), and Speedlight B is 2m (6.6 ft.), the combined brightness of the two Speedlights will be:

$$A : B = 1^2 : 2^2 = 1 : 4 \text{ (in meters) or } 3.3^2 : 6.6^2 = \text{approx. } 11 : 44 \text{ (in feet)}$$

Therefore, the illumination provided by Speedlight A is four times (or two steps) brighter than that provided by Speedlight B.

Making test shots

- Making test shots before shooting is recommended.

Multiple flash shooting using cords

Sample photographs and the positions of the Speedlights



Multiple flash shooting (using 3 flash units)



Single flash shooting (on-camera flash unit)

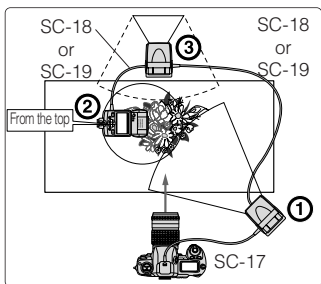

The master flash unit ① used off-camera illuminates the subject from the side to create a more natural-looking picture, and slave flash units ② and ③ illuminate the subject from the top and the rear to eliminate shadows, helping to give a better rendition of the subject.

Shooting data

- Camera: F100 (1/250 sec. f/11)
- Focal length: 70mm
- Master flash unit ① : SB-80DX set to Standard TTL flash
- Slave flash units ②, ③ : Two SB-80DX units set to Standard TTL flash

◆ Available flash modes for multiple flash shooting using cords

- Multiple flash shooting using cords can be performed in two ways: (1) TTL multiple flash and (2) Manual multiple flash.
- Performing multiple flash shooting in the Manual mode is not recommended, since it is difficult to obtain the correct exposure. Use the TTL auto flash mode with cameras compatible with TTL auto flash.
- Manual flash is possible with all Nikon cameras, including Digital SLRs cameras.
- Use of the SB-50DX and SB-23 as slave flash units is not recommended, because the standby function cannot be canceled.
- Even when a master flash unit is used off-camera, the shutter speed is automatically set through the optional TTL Remote Cord SC-17 in the TTL auto flash mode.

◆Connecting the master and slave flash units

- Refer to “System chart for TTL multiple flash” (p. 80). Also see the instruction manuals of your cameras, Speedlights, and accessories.
- Use the optional TTL Remote Cords SC-18 or SC-19 to connect the SB-80DX to more than one slave flash unit.
- Use the optional Multi-Flash Adapter AS-10, if the slave flash units are not equipped with multiple flash terminals.
- Use optional Multi-Flash Adapter AS-10 to attach the slave flash unit(s) to a tripod.

◆The maximum number of flash units to be connected using cords

- Up to five units including the master flash unit can be used for multiple flash photography at a total cable length of 10m (33 ft.).
- Make sure the combined total of the coefficients in the table below for all flash units used together does not exceed 20 at 20°C (68°F) or 13 at 40°C (104°F).
- If it exceeds these figures, you may not be able to take a second shot after the first one. In this case, turn off the power of all flash units and reduce the total number of flash units connected.

Speedlight	Coefficient
SB-80DX, SB-50DX, SB-30, SB-29, SB-29s, SB-28, SB-28DX, SB-27, SB-26, SB-25, SB-24, SB-22s, SB-14, SB-11, SB-140	1
SB-23, SB-21, SB-17, SB-16, SB-15	4
SB-22	6
SB-20	9

Multiple flash shooting using cords

◆ TTL multiple flash

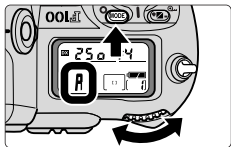

- 1 Set the camera's exposure mode to Aperture-Priority Auto (**A**) or Manual (**M**).



- 2 Attach the master flash unit to the camera, turn the power on, and set the flash mode to TTL auto flash.

- Available TTL auto flash modes are Matrix Balanced Fill-Flash, Center-Weighted Fill-Flash/Spot Fill-Flash, and Standard TTL flash.

For the usable camera/lens/exposure mode/metering system combination, see page 36.

- 3D Multi-Sensor Balanced Fill-Flash and Multi-Sensor Balanced Fill-Flash cannot be used, because monitor preflashes are fired.

- D-TTL multiple flash shooting using cords is not possible with digital SLRs cameras.

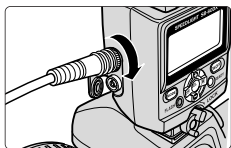

- 3 Turn off all the flash units before connecting the master flash unit to the slave flash units using optional TTL Remote Cords SC-18 or SC-19.

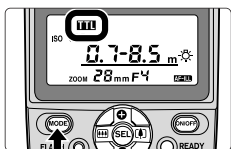

- 4 Turn on all slave flash units and set the flash mode on all slave flash unit to TTL auto flash.

- 5 Confirm the aperture and flash shooting distance range as in normal TTL auto flash shooting, then shoot.

- See page 28 about the TTL auto flash mode.

- When the flash has fired at its maximum output and underexposure may have occurred, the ready-light on the SB-80DX blinks for approx. 3 sec. To compensate, use a wider aperture or move closer to the subject and reshoot.

◆Manual multiple flash

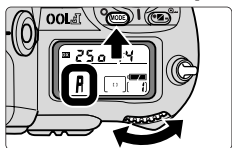

- 1 Set the camera's exposure mode to Aperture-Priority Auto (**A**) or Manual (**M**).

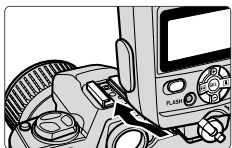

- 2 Turn off the power and attach the master flash unit to the camera.

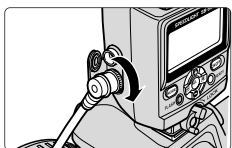

- 3 Connect the sync terminal on the master flash unit to the slave flash unit using optional Sync Cords SC-11 or SC-15.

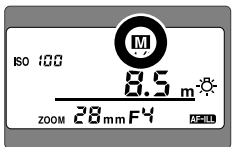

- 4 Turn on the power of all flash units and set the flash mode on all units to Manual flash.
 - The flash output level can be adjusted on the SB-80DX, SB-28, etc., if necessary (p. 45).
 - FP High-Speed Flash sync and Repeating flash are not possible.
- 5 Confirm the aperture and flash shooting distance as in normal Manual flash shooting, then shoot.
 - See page 46 about the Manual flash mode.

System chart for TTL multiple flash

- Speedlights SB-11, SB-14, SB-140, and SB-21B cannot be used with the F-401/N4004 or F-401s/N4004s as either master or slave flash units.

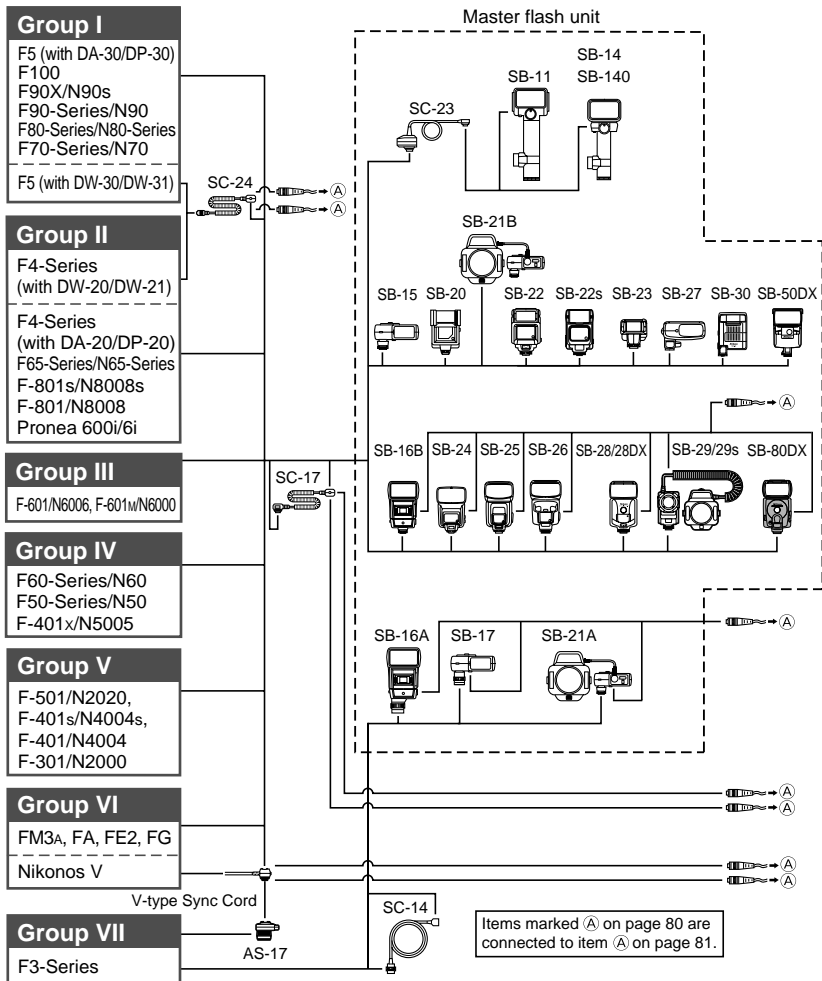

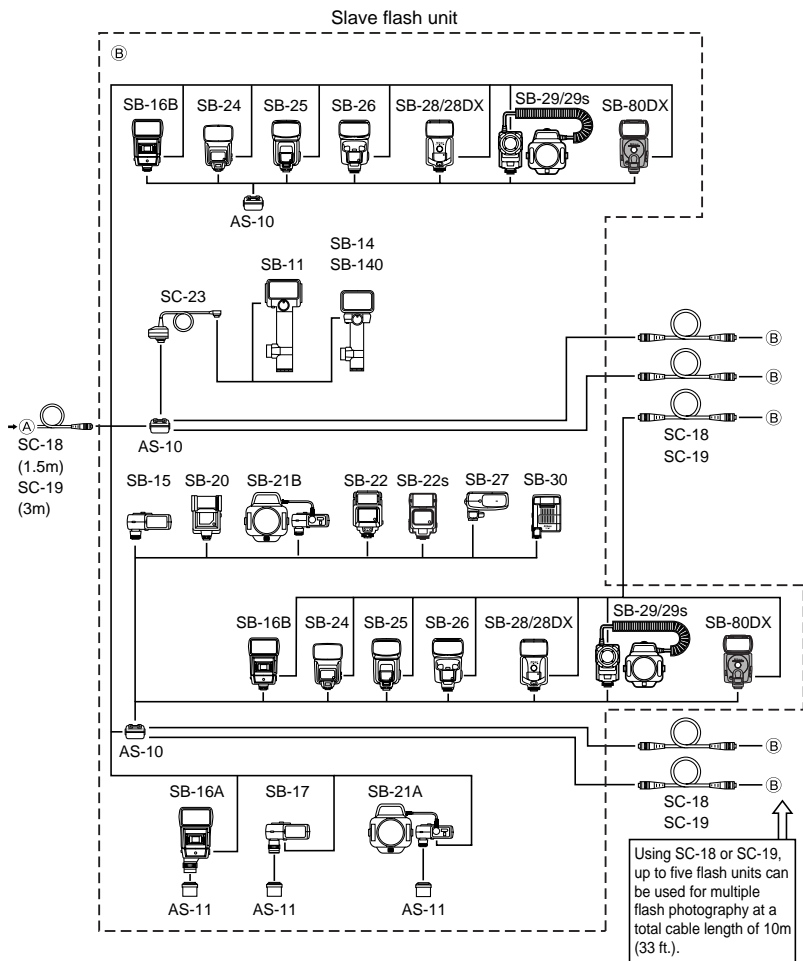

Wireless multiple flash shooting

Wireless multiple flash can be operated in two ways: (1) In the A (auto) mode, in which the wireless slave flash units start and stop firing in sync with the master Speedlight, and (2) in the M (manual) mode, in which the wireless slave flash units only fire in sync with the master Speedlight.

- In wireless multiple flash, the master flash unit triggers and controls the flash duration of the slave flash unit(s).
- The camera's built-in Speedlight can also be used as a master flash unit.
- Speedlights compatible with TTL auto flash, but having no wireless multiple flash function, can be used as the master flash unit. The optional Wireless Slave Flash Controller SU-4 allows you to use any Speedlight as a slave flash unit.

Wireless multiple flash shooting and examples of effective Speedlight placement



Wireless multiple flash (two flash units)



Single flash (off-camera flash unit)

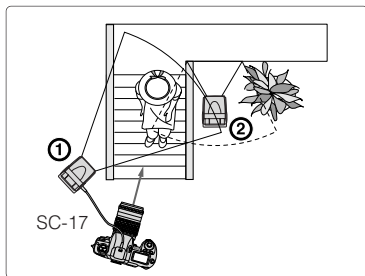

The master flash unit ① used off-camera illuminates the subject from the side to create a more natural-looking picture, and the slave flash unit ② softens the shadows cast by the subject.

Shooting data

- Camera: F100 (1/250 sec., f/8)
- Focal length: 50mm
- Master flash unit ①: SB-80DX set to Standard TTL flash
- Slave flash unit ②: SB-80DX set to Auto wireless slave flash mode



Wireless multiple flash (four flash units)



Single flash (on-camera flash unit)

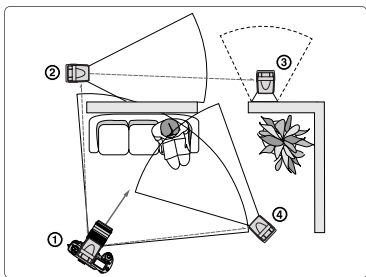

Three slave flash units are used. Slave flash unit ④ is used to eliminate the shadow caused by the master flash unit ①, while slave flash units ② and ③ brightly illuminate the subject from behind as well as the background to create a more natural-looking picture.

Shooting data

- Camera: F100 (1/125 sec, f/5.6 + 1/2)
- Focal length: 40mm
- Master flash unit ①: SB-80DX set to Standard TTL flash
- Slave flash units ②, ③, ④: Three SB-80DX units set to Auto wireless slave flash

Notes on setting the slave flash units.

- Position the slave flash unit (usually closer to the subject than the camera), so that light from the master flash unit can reach the light sensor of the slave flash unit. Particularly when taking pictures while holding a slave flash unit in your hand, make sure the slave flash unit is in front of the camera, so that light can reach the light sensor of the slave flash unit.
- Take care not to let light from the slave flash unit enter the camera lens directly or indirectly (in TTL auto flash mode) and prevent light from entering the master flash unit's light sensor for Non-TTL auto flash (in Non-TTL auto flash mode). Otherwise, the correct exposure cannot be obtained.
- There is no limit to the number of slave flash units that can be used together. However, if too much light from other slave flash units enters the light sensor of the master flash unit, correct operation may not be possible. Practically, the number of slave flash units should be limited to three.

◆ Activating and canceling the wireless flash mode using Custom settings



- 1** Press the button for more than 2 sec. to display the Custom settings mode.
- 2** Press the or button to choose the “Wireless flash mode.”
- 3** Press the or button to select “ON.”
- 4** Press the button for more than 2 sec. or press the button to return to the normal setting mode.
- 5** Detach the SB-80DX from the camera.
- 6** Press the button until the wireless flash indicator appears on the LCD panel.
 (Auto mode) \leftrightarrow (Manual mode)

- When the SB-80DX is attached to the camera after activating the Wireless flash mode, the indicator appears on the LCD panel, showing that the SB-80DX can be used as a wireless master flash unit. When the flash unit is detached as it is, the indicator automatically changes to or and you can use the SB-80DX as a wireless slave flash unit.
- With the SB-80DX attached to Digital SLRs cameras, the wireless flash mode is canceled and no wireless flash indicator appears on the LCD panel when the flash mode is set to D-TTL auto flash. Therefore, be sure to set the flash mode to other than D-TTL auto flash.

◆ Wireless master flash unit

- The SB-80DX, when set as a wireless master flash unit, can be used as a normal flash unit, but Monitor Preflashes will not fire even if Automatic Balanced Fill-Flash with TTL Multi-Sensor is selected.
- Use of a wireless master flash unit set to the TTL auto flash mode is recommended. With Nikon Digital SLRs cameras, use a wireless master flash unit set to the Auto Aperture or Non-TTL auto flash mode.

◆ Wireless slave flash unit

- When the flash unit is used off-camera, the wireless slave flash mode is activated and the indication toggles between $\overline{A} \rightarrow$ (auto) and $\overline{M} \rightarrow$ (manual) mode every time you press the **(MODE)** button.

A (auto) mode:

- The wireless slave flash unit starts and stops firing in sync with the master Speedlight.
- The maximum shooting distance of the SB-80DX's light sensor is approx. 7m (23 ft.).

M (manual) mode:

- The wireless slave flash unit only fires in sync with the master Speedlight.
- The maximum shooting distance of the SB-80DX's light sensor is approx. 40m (131 ft.).
- The flash output level can be set from M1/1 to M1/128.

Note

- Do not leave the power of the wireless slave flash unit on—this includes Speedlights mounted on the SU-4. Otherwise, ambient electric noise due to a discharge of static electricity, etc. may accidentally trigger the flash.

How to prevent accidental flash firing

- Press the Modeling illuminator button on the SB-80DX to avoid accidental firing in sync with other Speedlights. The SB-80DX will not fire, while this button is pressed.

◆ Wireless multiple flash shooting in A (auto) mode

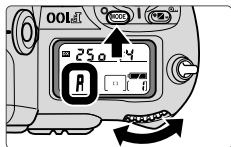

- 1 Set the camera's exposure mode to Aperture-Priority Auto (**A**) or Manual (**M**).



- 2 Set up all Speedlights as master and slave flash units.



- 3 Set all SB-80DX units (used as the master and slave flash units) to the Wireless flash mode.

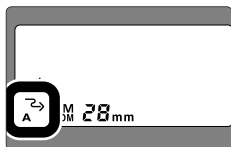

- 4 Press the **(MODE)** button on the slave flash unit to activate the A (auto) mode.

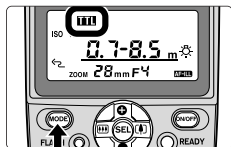

- 5 Set the flash mode of the master Speedlight to the TTL auto flash mode.

- With Nikon Digital SLRs cameras, wireless flash cannot be set, if the flash mode is set to D-TTL auto flash. In this case, set the flash mode to Auto Aperture or Non-TTL auto flash.

- 6 Confirm the aperture and flash shooting distance range as in normal TTL auto flash shooting, then shoot.

- See page 28 about the TTL auto flash mode.
- See pages 42, 40 about the Auto Aperture or Non-TTL auto flash mode with Digital SLRs cameras.
- Flash operation can be confirmed by the ready-light or the beeping sound (p. 89).

◆ Wireless multiple flash shooting in M (manual) mode

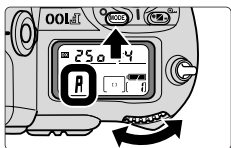

- 1 Set the camera's exposure mode to Aperture-Priority Auto (**A**) or Manual (**M**).

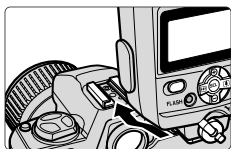

- 2 Set up all Speedlights as the master and slave flash units.



- 3 Set all SB-80DX units (used as the master and slave flash units) to the Wireless flash mode.



- 4 Press the **MODE** button on the slave flash unit to activate the M (manual) mode.

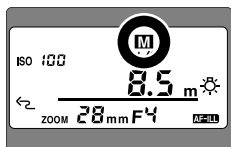

- 5 Set the flash mode of the master Speedlight to the Manual flash mode.
 - The Non-TTL auto flash (A) mode can also be selected on the wireless slave flash unit. In this case, the flash unit controls the flash output based on the aperture and ISO sensitivity which are set on the slave flash unit, and automatically stops firing in sync with the master flash unit (p. 40).
- 6 Confirm the aperture and flash shooting distance as in normal Manual flash shooting, then shoot.
 - See page 45 about Setting the flash output level.
 - See page 46 about the Manual flash mode.

Adjusting the flash output level in M (manual) mode

Adjusting the slave flash unit's flash output level manually

- Use the following equation to determine the proper manual flash output level of the slave flash unit, depending on your creative preferences.

$$GN = F \times D$$

where GN is the guide number of the slave flash unit (in meters/feet), F is the lens aperture in use, and D is the distance between the slave flash unit and the subject (in meters/feet).

For example, when using an ISO sensitivity of 100 and shooting a subject at a distance of 2m (6.6 ft.) with the SB-80DX's zoom-head position adjusted to 28mm, and a lens aperture of f/4,

$$GN = 4 \times 2 = 8 \text{ (in meters)}$$

$$GN = 4 \times 6.6 = \text{approx. } 26 \text{ (in feet)}$$

Therefore, to get the correct exposure, refer to the Guide Number table (p. 45) and adjust the flash output level to M1/16.

- Refer to "Determining the aperture and flash output level in the Manual mode" (p. 44).

Adjusting the slave flash unit's flash output level in the Non-TTL auto flash (A) mode

- Determine the flash output level by setting the aperture on the slave flash unit and camera.

- 1** Set the same ISO sensitivity on the slave flash unit as set on your camera.
- 2** Set the same aperture on both the lens and the slave flash unit to obtain the correct exposure.
 - Depending on your creative preferences, you can intentionally overexpose or underexpose the picture by modifying the aperture.
 - The above setting is applicable only when both the master and slave flash units are pointed in the same directions. Not applicable, if the directions differ.
 - Refer to "Setting apertures in the non-TTL auto flash mode" (p. 41) for more details.

◆ Confirming flash operation using the ready-light or the beeping sound

- You can confirm flash operation by checking the ready-light on the Speedlight or the beeping sound during and after shooting.

Activating and canceling the SB-80DX's beeping sound using Custom settings

- When the SB-80DX is used as a wireless slave flash unit, you can monitor its operation by listening to the beeping sound (p. 90). This function can be activated or canceled using the Custom settings.



- 1** Detach the SB-80DX from the camera.
- 2** Press the **SEL** button for more than 2 sec. to display the Custom settings mode.
- 3** Press **+** or **-** button to choose "Sound monitor in the wireless flash mode."
- 4** Press the **Beep** or **Beep Off** button to select:
 - Beep** : Sound on
 - Beep Off** : Sound off
- 5** Press **SEL** button for more than 2 sec. or press the **ON/OFF** button to return to the normal setting mode.

Confirming flash operation using the ready-light or beeping sound

Master flash unit	Slave flash unit		Speedlight condition
	Ready-light	Beeping sound	
Lights up	Lights up	One beep	Ready to fire
Lights up or does not come on (not blinking)	Lights up or does not come on (not blinking)	Two beeps	Fired properly
Blinks for approx. 3 sec.	Blinks for approx. 3 sec.	Beeps for approx. 3 sec.	Both the master and slave flash units have fired at full output and light may have been insufficient for correct exposure. Use a wider aperture and reshoot.
Lights up or does not come on (not blinking)	Blinks for approx. 3 sec.	Beeps for approx. 3 sec.	The slave flash unit has fired at full output and light may have been insufficient for correct exposure. The light sensor could not detect when to stop firing in sync with the master flash unit, because a strong reflection from the slave flash unit itself or light from another slave flash unit may have entered the light sensor window. Change the direction or position of the slave flash unit and reshoot.

Reference information

Information on optional accessories and tips on Speedlight care are presented here. Following that are notes on batteries, troubleshooting, and the SB-80DX's specifications.

Optional accessories

◆ Accessories for multiple flash

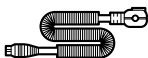
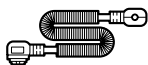

TTL Remote Cord SC-17 (approx. 1.5m or 4.9 ft)
TTL Remote Cord SC-24 (approx. 1.5m or 4.9 ft)
TTL Remote Cords SC-17/SC-24 provide TTL auto flash operation when the SB-80DX is used off-camera. Their flash shoes come with one tripod socket and two TTL multiple flash terminals. The TTL Remote Cord SC-24 is for use with F5 cameras mounted with a High-Magnification Finder DW-30 or DW-31, or F4 cameras having a High-Magnification Finder DW-20 or DW-21.



TTL Multi-Flash Sync Cord SC-18 (approx. 1.5 m or 4.9 ft)
TTL Multi-Flash Sync Cord SC-19 (approx. 3 m or 9.8 ft)
Multi-Flash Sync Cords SC-18/SC-19 are useful for connecting the SB-80DX to the multiple flash terminal of the SC-17 or AS-10 for TTL multiple flash operation.



TTL Multi-Flash Adapter AS-10
Use the Multi-Flash Adapter AS-10 when connecting more than three flash units together for TTL multiple flash operation, or if the slave flash units are not equipped with multiple flash terminals. The AS-10 comes with one tripod socket and three TTL multiple flash terminals.



Sync Cord SC-11 (approx. 25 cm or 9.8 in.)



Sync Cord SC-15 (approx. 1 m or 3.3 ft)
Sync Cords SC-11 and SC-15 are handy when you want to use the SB-80DX off-camera or for use with cameras not having accessory shoes. These cords also allow you to perform multiple flash operation in the Manual mode.



Sync Terminal Adapter AS-15
The Sync Terminal Adapter AS-15 is necessary when connecting the SB-80DX to cameras not having a sync terminal.



Wireless Slave Flash Controller SU-4

Useful for multiple flash photography, the SU-4 features a built-in, movable light sensor and an accessory shoe for attachment of a slave flash unit. The SU-4's light sensor not only triggers the slave unit to fire in sync with the master unit, but controls the flash duration of the slave unit to provide wireless TTL, Non-TTL, or Manual operation.



TTL Flash Unit Coupler AS-17 for F3-Series cameras

Dedicated adapter for F3-Series cameras providing TTL flash operation with Nikon Speedlights such as SB-80DX featuring an ISO-type mounting foot (not designed for the F3).

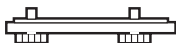

Bracket SK-7

A metal plate with attachment screws allowing the camera and Speedlight to be positioned side by side. Use the optional TTL Multi-Flash Adapter AS-10 to attach the SB-80DX on Bracket SK-7.

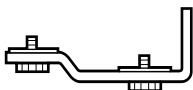

Multi-Flash Bracket Unit SK-E900

(One AS-E900 Multi-Flash Adapter is included with the SK-E900)

Multi-Flash Adapter AS-E900

The SB-80DX can be used as a multiple flash unit with Nikon COOLPIX 900 series digital cameras by attaching the COOLPIX to Multi-Flash Bracket unit SK-E900 and connecting the SB-80DX to the multi-flash terminal of the COOLPIX using the Multi-Flash Adapter AS-E900 (p. 32).



◆ Using external power sources

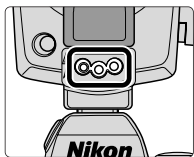

Connecting to an external power source

- To use an external power source, remove the cover and connect its power cord to the SB-80DX's external power source terminal.
- Using external power sources made by another manufacturer is not recommended.

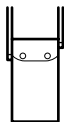

Nikon DC Unit
SD-7

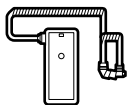

Nikon High-Performance
Battery Pack
SD-8A

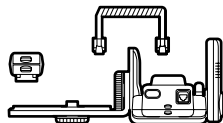

Power Bracket Unit
SK-6A

Specifications

External power source	Battery type required	Min. recycling time (approx.)	Min. number of flashes/recycling time (approx.)
DC Unit SD-7*1	C-type alkaline-manganese (x 6)	2.5 sec.	430 times/2.5-30 sec.
High-Performance Battery Pack SD-8A*2	AA-type alkaline-manganese (x 6)	2.5 sec.	400 times/2.5-30 sec.
	AA-type NiCd (1000mAh) (x 6)	2 sec.	190 times/2-30 sec.
	AA-type Ni-MH (x 6)	2 sec.	300 times/2-30 sec.
	AA-type lithium (x 6)*3	2 sec.	300 times/2-30 sec.
Power Bracket Unit SK-6A*1	AA-type alkaline-manganese (x 4)	3 sec.	300 times/3-30 sec.
	AA-type NiCd (1000mAh) (x 4)	2.5 sec.	150 times/2.5-30 sec.
	AA-type Ni-MH (x 4)	2.5 sec.	250 times/2.5-30 sec.
	AA-type lithium (x 4)*3	3.5 sec.	330 times/3.5-30 sec.

*1 With AA-type alkaline-manganese batteries in the SB-80DX.

*2 With the same type of batteries in both the external power source and the SB-80DX.

*3 When fired at an interval of 120 seconds.

- The above data may vary due to variations in performance or whether fresh or old batteries are used.
- In rare cases, when firing the modeling illuminator with the SD-8A or SK-6A attached, the SB-80DX may be powered by its own batteries, and the external power source does not operate. This is not a malfunction.



WARNING

Never use thinner, benzene, or other active agents for cleaning the Speedlight, as this may damage the Speedlight, cause it to catch on fire, or harm your health.

◆ **Cleaning**

- Use a blower brush to remove dirt and dust from the SB-80DX and clean it with a soft, clean cloth. After using the SB-80DX near saltwater, wipe the SB-80DX with a soft, clean cloth slightly moistened with plain water to remove salt, and then dry it using a dry cloth.
- On rare occasions, the LCD may turn on or turn dark, due to static electricity. This is not a malfunction. The display will soon return to normal.
- Do not drop the SB-80DX or hit it against a hard surface, as this may damage its precision mechanisms. Do not apply strong pressure to the LCD panel.

◆ **Storage**

- Store the SB-80DX in a cool, dry place to prevent malfunctions due to high humidity, as well as the growth of mold or mildew.
- Keep the SB-80DX away from chemicals such as camphor or naphthalene. Avoid exposing the SB-80DX to magnetic waves from TVs or radios.
- Do not use or leave the SB-80DX in locations subject to high temperatures such as those encountered near a heater or stove, as this may cause damage.
- When not using the SB-80DX for more than two weeks, be sure to remove the batteries before storage to prevent malfunctions due to battery leakage.
- Take the SB-80DX out about once a month, insert the batteries and fire the unit several times to reform the capacitor.
- Change the desiccant occasionally since it does not absorb moisture effectively after a while.

◆ **Operating location**

- An extreme temperature change can cause condensation inside the SB-80DX. When taking the SB-80DX to a very hot place from a very cold place or vice versa, place it inside an airtight container such as plastic bag. Leave it inside for a while, then expose the SB-80DX gradually to the outside temperature.
- Avoid exposing the SB-80DX to strong magnetism or radio waves from TVs or high-voltage power transmission towers, as this may cause it to malfunction.

Notes on batteries

◆ Usable batteries

- Use four AA-type batteries (1.5V or lower) of any of the following types.
- High-power manganese batteries are not recommended.
- Using an external power source (p. 94) increases the number of flashes and provides faster recycling times.

Alkaline-manganese (1.5V) battery

- Non-rechargeable batteries. They should not be charged in a battery charger. Otherwise, they may explode.

Lithium (1.5V) battery

- Non-rechargeable batteries. They should not be charged in a battery charger. Otherwise, they may explode.
- Depending on battery specifications, when the battery becomes hot, the safety circuits are activated, cutting off power. This often occurs when the flash unit is operated in the repeating flash mode. Battery power will recover when the temperature returns to normal.

NiCd battery (rechargeable, 1.2V) / Ni-MH (rechargeable, 1.2V)

- Rechargeable batteries. Before recharging the batteries, be sure to read the instruction manuals for your batteries and battery charger for detailed information on how to handle and charge the batteries.

◆ Notes on handling batteries

- Because flash consumes a large amount of battery power, rechargeable batteries may not operate properly before reaching the end of their stated life-span or the number of charging/discharging as specified by the battery manufacturer.
- When replacing batteries, replace all four batteries at the same time. Do not mix battery types or brands or use old with new batteries.
- When installing batteries, turn the power of the Speedlight off, and never reverse the polarity of the batteries.
- When the battery terminals become soiled, remove the dirt and smudges before use, as this may cause a malfunction.
- Battery power tends to weaken as the temperature drops. It also gradually decreases when batteries are not used for a long period of time and recovers after a short break following intensive use. Be sure to check battery power and replace the batteries with fresh ones, if you notice any delays in recycling time.
- Do not store batteries in locations subject to high temperatures and high humidity.



Warning

- Batteries shall not be exposed to excessive heat such as sunshine, fire or the like.
- Dry batteries shall not be subjected to charging.
- Do not expose the SB-80DX to water as this may result in electric shock or cause the unit to catch on fire.





Troubleshooting

If a warning indication appears on the SB-80DX's LCD panel or inside the camera's viewfinder, use the following chart to determine the cause of the problem before you take your Speedlight to a Nikon service center for repair.

Problems with the SB-80DX

Problem	Cause	Ref. page
The power cannot be turned on.	The batteries are not correctly installed.	p. 16
The ready-light does not light up.	<ul style="list-style-type: none">• Battery power is weak.• The standby function is activated and operating.	p. 17 p. 19
The power turns off automatically.	The batteries are extremely exhausted.	p. 17
A strange sound can be heard caused by the flash head zooming back and forth even when the SB-80DX is turned off.	The batteries are extremely exhausted.	p. 17
The flash shooting distance range does not appear.	The flash head is adjusted to other than the horizontal/front or down -7° position.	p. 21
No  ,  , or  indicator appears in TTL auto flash mode.	The camera's exposure mode or metering system is not correctly set or a non-CPU lens is mounted.	p. 36
The zoom-head position cannot be adjusted to other than 14mm or 17mm.	The built-in wide-flash adapter is in use or the Nikon Diffusion Dome is attached.	p. 69 p. 72

Warning indicators in the SB-80DX

Problem	Cause	Ref. page
The ready-light blinks for 3 sec. after firing. The underexposure indicator blinks and the amount of underexposure is displayed, depending on the camera in use.	Underexposure may have occurred.	p. 31
The underbar blinks.	The flash head is tilted down -7°.	p. 21
The zoom-head position indication blinks.	"Emergency mode" is set to ON.	p. 98
A small M above the "ZOOM" indication blinks.	"Canceling the power zoom function" is set to ON.	p. 25
The   indicators and the zoom-head position blink.	The built-in wide-flash adapter is used in the FP High-Speed Flash sync mode.	p. 51
 blinks.	The SB-80DX is removed from the camera while the  setting is ON.	p. 51
The aperture indicator displays "FEE" and the shutter cannot be released.	The aperture on the lens is not set at its minimum.	—

Problem	Cause	Ref. page
In the Auto Aperture A flash mode, the aperture and the flash output level compensation value blink and the flash shooting distance range disappears.	The aperture or flash output level compensation value set is out of the usable flash shooting distance range.	p. 42
The zoom-head position displays "- - mm" and blinks.	In rare cases, this happens but is not a malfunction. Turn off the power and then turn it back on.	—
Three beeps sound during wireless multiple flash shooting.	The flash has fired at its maximum output and underexposure may have occurred.	p. 90

If the built-in wide-flash adapter is broken off accidentally

- The wide-flash adapter may be broken off, if it receives a strong impact while set on the flash head. If it becomes broken, visit your nearest authorized Nikon service center for repair.

Setting the zoom-head position when the wide-flash adapter is broken off using Custom settings

- It is no longer possible to set the zoom-head position to other than 14mm or 17mm. In this case:



- 1 Press the **SEL** button for more than 2 sec. to display the Custom settings mode.
- 2 Press the **+** or **-** button to choose "Emergency mode."
- 3 Press the **ON** or **OFF** button to set it to "ON."
- 4 Press the **SEL** button for more than 2 sec. or press the ON/OFF button to return to the normal setting mode. The zoom-head position indicator blinks, making it possible to adjust the zoom-head automatically or manually.



























Ready-light warning inside the camera's viewfinder

Problem	Cause	Ref. page
Cameras in Groups I (except for F70-Series/N70) to VI and Digital SLRs cameras		p. 20
The ready-light blinks when pressing the shutter release button slightly in the TTL auto flash mode.	The SB-80DX is not correctly attached to the camera.	
Cameras in Groups V and VI		p. 38
The ready-light blinks when the power is turned on in TTL auto flash mode.	The ISO sensitivity set on the camera is higher than the available range of the Speedlight. The ISO sensitivity set on the camera is higher or lower than the available range for the FA camera.	
Cameras in Group VI		p. 38
The ready-light blinks in the TTL auto flash mode.	The shutter speed is set to M90, M250, or B (bulb).	
FM3A, New FM2 cameras		—
The ready-light blinks.	The shutter speed set is faster than the flash sync speed.	
New FM2, F55/N55 cameras.		p. 21
The ready-light blinks when the flash mode is set to TTL auto flash.	The SB-80DX's flash mode is set to TTL auto flash.	

Note

The SB-80DX incorporates a microcomputer to control flash operations. In rare cases, the SB-80DX may not work properly even after fresh batteries are properly installed. If this happens, replace the batteries while the SB-80DX's power is turned on.





Specifications

Electronic construction	Automatic Insulated Gate Bipolar Transistor (IGBT) and series circuitry																																		
Flash exposure control	<p>Selected by pressing (MODE) button.</p> <table border="1" data-bbox="310 273 958 784"> <thead> <tr> <th>Indicator</th> <th>Available flash operation</th> </tr> </thead> <tbody> <tr> <td>TTL + </td> <td>3D Multi-Sensor Balanced Fill-Flash/ Multi-Sensor Balanced Fill-Flash</td> </tr> <tr> <td>D + TTL + </td> <td>3D Multi-Sensor Balanced Fill-Flash/Multi-Sensor Balanced Fill-Flash for Digital SLRs</td> </tr> <tr> <td>TTL + </td> <td>Matrix Balanced Fill-Flash or Center-Weighted Fill- Flash/Spot Fill-Flash</td> </tr> <tr> <td>D + TTL + </td> <td>Center-Weighted Fill-Flash for Digital SLRs</td> </tr> <tr> <td>TTL</td> <td>Standard TTL Flash, Matrix Balanced Fill-Flash, Center-Weighted Fill-Flash/Spot Fill-Flash</td> </tr> <tr> <td>D + TTL</td> <td>Standard TTL Flash for Digital SLRs</td> </tr> <tr> <td>A</td> <td>Non-TTL Auto Flash</td> </tr> <tr> <td>AA</td> <td>Auto Aperture Flash</td> </tr> <tr> <td>M</td> <td>Manual Flash</td> </tr> <tr> <td>M + </td> <td>Repeating Flash</td> </tr> <tr> <td>M + FP</td> <td>FP High-Speed Flash sync</td> </tr> </tbody> </table> <p>Settings on camera</p> <table border="1" data-bbox="310 833 958 993"> <thead> <tr> <th>Indicator</th> <th>Available flash operation</th> </tr> </thead> <tbody> <tr> <td>*</td> <td>Red-eye reduction</td> </tr> <tr> <td></td> <td>Rear-curtain sync</td> </tr> <tr> <td></td> <td>Slow-sync</td> </tr> <tr> <td></td> <td>Red-eye reduction in slow-sync</td> </tr> </tbody> </table> <p>* Appears on the SB-80DX's LCD panel</p>	Indicator	Available flash operation	TTL + 	3D Multi-Sensor Balanced Fill-Flash/ Multi-Sensor Balanced Fill-Flash	D + TTL + 	3D Multi-Sensor Balanced Fill-Flash/Multi-Sensor Balanced Fill-Flash for Digital SLRs	TTL + 	Matrix Balanced Fill-Flash or Center-Weighted Fill- Flash/Spot Fill-Flash	D + TTL + 	Center-Weighted Fill-Flash for Digital SLRs	TTL	Standard TTL Flash, Matrix Balanced Fill-Flash, Center-Weighted Fill-Flash/Spot Fill-Flash	D + TTL	Standard TTL Flash for Digital SLRs	A	Non-TTL Auto Flash	A A	Auto Aperture Flash	M	Manual Flash	M + 	Repeating Flash	M + FP	FP High-Speed Flash sync	Indicator	Available flash operation	 *	Red-eye reduction		Rear-curtain sync		Slow-sync		Red-eye reduction in slow-sync
Indicator	Available flash operation																																		
TTL + 	3D Multi-Sensor Balanced Fill-Flash/ Multi-Sensor Balanced Fill-Flash																																		
D + TTL + 	3D Multi-Sensor Balanced Fill-Flash/Multi-Sensor Balanced Fill-Flash for Digital SLRs																																		
TTL + 	Matrix Balanced Fill-Flash or Center-Weighted Fill- Flash/Spot Fill-Flash																																		
D + TTL + 	Center-Weighted Fill-Flash for Digital SLRs																																		
TTL	Standard TTL Flash, Matrix Balanced Fill-Flash, Center-Weighted Fill-Flash/Spot Fill-Flash																																		
D + TTL	Standard TTL Flash for Digital SLRs																																		
A	Non-TTL Auto Flash																																		
A A	Auto Aperture Flash																																		
M	Manual Flash																																		
M + 	Repeating Flash																																		
M + FP	FP High-Speed Flash sync																																		
Indicator	Available flash operation																																		
 *	Red-eye reduction																																		
	Rear-curtain sync																																		
	Slow-sync																																		
	Red-eye reduction in slow-sync																																		

Angle of coverage	Variable in 7 steps, plus three steps with wide-flash adapter and Nikon Diffusion Dome			
	Zoom-head position		Angle of coverage	
			Vertical	Horizontal
	14mm *1	14mm	110°	120°
	14mm *2	14mm	110°	120°
	17mm *2	17mm	100°	110°
	24mm	24mm	60°	78°
	28mm	28mm	53°	70°
	35mm	35mm	45°	60°
	50mm	50mm	34°	46°
	70mm	70mm	26°	36°
85mm	85mm	23°	31°	
105mm	105mm	20°	27°	
	*1 With the Nikon Diffusion Dome attached			
	*2 With the built-in wide-flash adapter in place			
Bounce capability	Flash head tilts down to -7° or up to 90° with click-stops at -7°, 0°, 45°, 60°, 75°, 90°; Flash head rotates horizontally 180° to the left or 90° to the right with click-stops at 0°, 30°, 60°, 90°, 120°, 150°, 180°			
Power ON/OFF button	<ul style="list-style-type: none"> • Press ON/OFF button for approx. 0.5 sec. to turn SB-80DX on or off. • Standby function can be set. 			
Power source/ min. recycling time/no. of flashes (at M1/1 output)	Four AA-type penlight batteries (1.5V or lower) of any of these types: Alkaline-manganese (1.5V), Lithium (1.5V), NiCd (1.2V), or Ni-MH (1.2V)			
	Battery type	Min. recycling time (approx.)*	Min. number of flashes/ recycling time (approx.)*	
	Alkaline-manganese	6 sec.	150/6-30 sec.	
	Lithium	7.5 sec.	190/7.5-30 sec.	
	NiCd (1000mAh)	4.0 sec.	90/4-30 sec.	
Ni-MH	4.0 sec.	110/4-30 sec.		
	* With fresh batteries.			
	• M1/1 output without use of AF-assist illuminator, zoom operation, and LCD panel illuminator.			

Specifications

External power sources (optional)	External power source	Battery type
	DC Unit SD-7	Six C-type alkaline-manganese
	High-Performance Battery Pack SD-8A	Six AA-type alkaline-manganese
	Power Bracket Unit SK-6A	Four AA-type alkaline-manganese
Ready-light	<ul style="list-style-type: none"> • Lights up when SB-80DX is recharged and ready to fire. • Blinks for 3 sec. when flash fires at its maximum output, indicating light may have been insufficient (in TTL/D-TTL auto flash, Non-TTL Auto Flash, and Auto Aperture flash modes) 	
FLASH button	Performs test firing for determination of correct exposure. Turns SB-80DX on again after unit enters standby-off state.	
Flash duration (approx.)	1/1050 sec. at M 1/1 (full) output 1/1100 sec. at M 1/2 output 1/2700 sec. at M 1/4 output 1/5900 sec. at M 1/8 output 1/10900 sec. at M 1/16 output 1/17800 sec. at M 1/32 output 1/32300 sec. at M 1/64 output 1/41600 sec. at M 1/128 output	
Mounting foot lock lever	Provides secure attachment of SB-80DX to camera's accessory shoe using locking plate and mount pin to prevent accidental detachment.	
Exposure compensation	-3.0 to +3.0 EV in increments of 1/3 steps (or in 1/6 steps with Digital SLRs) in the TTL/D-TTL auto flash and Auto Aperture flash modes	
AF-assist illuminator	Automatically turns on when performing autofocus in dim light or in the dark with Nikon AF cameras. Effective shooting distance: Approx. 1m to 10m with a 50mm f/1.8 lens or shorter, depending on the lens in use.	
Wireless flash operation	A (auto) mode: The wireless slave flash unit starts and stops firing in sync with the master Speedlight. M (manual) mode: The wireless slave flash unit only fires in sync with the master Speedlight.	

Modeling illumination	The flash fires repeatedly at a reduced flash output level to provide illumination for previsualizing the modeling of the subject.
Custom settings	By pressing the  and  ,  , or  buttons, the following custom settings are possible: Wireless flash mode, Sound monitor in the wireless flash mode, AF-assist illuminator, Standby function, Selecting the distance unit (m, ft.), Canceling power zoom function, Emergency mode, and LCD panel illuminator.
Built-in wide-flash adapter	Allows SB-80DX to be used with 14mm or 17mm lens
Dimensions (W x H x D)	Approx. 70.5 x 127.5 x 91.5mm (2.8 x 5 x 3.6 in.)
Weight (without batteries)	Approx. 335g (11.8 oz.)
Accessories supplied	Nikon Diffusion Dome SW-10H, External power source terminal cap, Soft Case SS-80

These performance specifications are applicable when fresh batteries are used at normal temperatures (20°C/68°F).

Specifications and design are subject to change without notice.

Index

- Refer to the Speedlight parts (p. 8) and the LCD panel (p. 10) for each part name and display indicators.

Symbols

1/300 TTL high-speed flash sync mode.....	39
3D Multi-Sensor Balanced Fill-Flash.....	35
3D Multi-Sensor Balanced Fill-Flash for Digital SLRs.....	35

A

Amount of underexposure	31
Aperture-priority auto exposure (A) mode	27
Auto Aperture (AA) flash mode	42
Autofocus flash operation in dim light.....	62

B

Batteries.....	16
Beeping sound	89
Bounce flash operation.....	66
Built-in wide-flash adapter.....	25, 72

C

Camera groups and available flash modes	4
Center-Weighted Fill-Flash for Digital SLRs	35
Center-Weighted Fill-Flash/Spot Fill-Flash	35
Close-up flash operation	70
Control button quick reference.....	12
Control buttons	11
COOLPIX	32
CPU Nikkor lenses.....	14
Custom settings.....	12

D

D-TTL auto flash mode	34, 35
D-type Nikkor lenses	14

E

Exposure compensation.....	56
Exposure mode	26, 36
External power sources	17, 94

F

Flash head tilting/rotating lock release button	20
Flash modes	33
Flash output level compensation	56, 58
Flash shooting distance range	29
Flash sync mode	30
FP High-Speed Flash Sync mode	51
Front-curtain sync.....	30

G

G-type Nikkor lenses	14
Guide number.....	45

H

High-speed flash synchronization	51
--	----

I

ISO sensitivity	22
ISO sensitivity factors	45
ISO sensitivity range usable in TTL auto flash.....	23

L

LCD panel.....	10
LCD panel illuminator	10
Lenses	14

Light sensor window for wireless
slave flash8

M

Manual exposure (M) mode27
Manual flash operation46
Manual mode.....44
Master flash unit74

Matrix Balanced Fill-Flash35
Max. no. of frames during
continuous flash shooting53

Maximum number of repeating flashes
per frame48

Metering system26, 36
Minimum recycling times17

Modeling illumination61
Monitor Preflashes35

Mounting foot lock lever20
Multi-Sensor Balanced Fill-Flash35

Multi-Sensor Balanced Fill-Flash
for Digital SLRs.....35

Multiple flash operation74
Multiple flash shooting using cords.....76

N

Nikon Diffusion Dome25, 69
Non-CPU lenses14

Non-TTL auto flash mode40
Number of flashes17, 48

O

ON/OFF button18
Optional accessories.....92

P

Power zoom function24
Programmed auto (P)26

R

Ready-light9, 17
Rear-curtain sync61
Red-eye reduction60
Red-eye reduction control60
Repeating flash mode48

S

Selecting the distance unit (m or ft.)....13
Shutter-priority auto exposure (S) mode....27
Slave flash units74
Slow-sync flash mode.....60
Soft Case3
Specifications100
Speedlight parts8
Standard TTL flash35
Standard TTL flash for Digital SLRs.....35
Standby function.....19
Supplied accessories3
System chart for TTL multiple flash80

T

Test firing18
TTL auto flash mode35

U

Using the built-in bounce card69

W

Warning indicators.....97
Wireless flash mode84
Wireless master flash unit.....85
Wireless multiple flash shooting82
Wireless slave flash unit85

Z

Zoom-head position.....24, 101

Notes



No reproduction in any form of this manual, in whole or in part (except for brief quotation in critical articles or reviews), may be made without written authorization from NIKON CORPORATION.

Nikon

NIKON CORPORATION

FUJI BLDG., 2-3, MARUNOUCHI 3-CHOME,
CHIYODA-KU, TOKYO 100-8331, JAPAN