

Nikon



FIM3 A

FIM3A (E)

INSTRUCTION MANUAL



Getting Started

Thank you for purchasing this Nikon FM3A camera. Please read this instruction manual carefully for complete details on getting the most from your Nikon FM3A.

Your new Nikon FM3A features a Manual Exposure mode for total control of exposure, as well as a semi-automatic Aperture-Priority Exposure mode. Aperture Priority mode lets you adjust the aperture for the desired depth of field while the shutter speed is automatically adjusted accordingly. The FM3A incorporates a special hybrid shutter mechanism that offers the advantages of a mechanical focal plane shutter for use during manual operation, as well as an electronically controlled focal plane shutter for use during Aperture-Priority Auto Exposure operation. Even when the FM3A's battery power is fully exhausted, all shutter speeds remain functional in Manual Exposure mode.

The FM3A features a maximum shutter speed of 1/4000 sec., a flash sync speed of 1/250, multiple exposure control, interchangeable focusing screens, and the ability to use the MD-12 Motor Drive for high speed sequence photography. The Nikon FM3A's flash system offers TTL control in both Manual Exposure mode and Aperture-Priority Auto Exposure mode, and includes a flash compensation button that provides a natural looking flash result.

We hope you enjoy using your new Nikon FM3A camera, and would like to thank you for choosing Nikon.

Symbols used in this manual

Tips

Indicates items in boxes that contain important matters to be noticed first.



Indicates items to be checked, such as requirements and restrictions.



Indicates pages for reference.

...

Indicates supplementary descriptions.

Notice

■ Take trial shots

Take a few test shots before shooting important events like weddings or graduations.

■ Have Nikon spot-check your camera regularly

Nikon recommends that you have your camera serviced by an authorized dealer or service center at least once every two years.

■ Using your camera correctly

The Nikon FM3A's performance has been optimized for use with Nikon brand accessories. Accessories made by other manufacturers may not meet Nikon's criteria for specifications, and nonconforming accessories could damage the FM3A's components. Nikon cannot guarantee the FM3A's performance when it is used with other than Nikon brand accessories.

■ Supplied accessories



Body cap (white)



Battery (CR-1/3N)



Tripod mat

… When using a tripod with a lens of such large diameter that the lens touches the tripod, insert the tripod mat between the camera and tripod.

1 Prior to Use

Getting Started	2
Symbols used in this manual	2
Notice	3
Camera Parts (Body, Viewfinder indications)	6

2 Basic Operations for Shooting

Installing Batteries	10
Checking the Battery Power	11
Attaching/Detaching a Lens	12
Loading Film	13
Setting the Film Speed (DX-Coded Film)	15
Holding the Camera (How to press the shutter-release button)	16
Focusing	17
Shooting	18
Aperture-Priority Auto Exposure Mode	18
Manual Exposure Mode	20
Rewinding the Film	22

3 Controls in Detail ----- 23

Shutter-Speed Dial -----	24
Film-Advance Lever -----	25
Manual Film-Speed Setting -----	26
Exposure-Compensation Indicator -----	27
Frame Counter -----	29
Depth of Field Preview Lever -----	29
Film-Plane Indicator -----	30
Accessory Shoe and Sync-Cord Terminal -----	30

4 Steps of Advanced Photography ----- 31

Flash Photography -----	32
AE-Lock Photography -----	36
Self-Timer Photography -----	37
Multiple-Exposure Photography -----	38

5 Additional Information ----- 39

Shutter Speed and Aperture Setting -----	40
Depth of Field -----	41
Light-Metering Methods -----	41
Lens Compatibility -----	42
Optional Accessories -----	44
Changing the Focusing Screen -----	46
Tips on Handling the Camera and Batteries -----	48
Glossary -----	50
Specifications -----	54

Camera Parts

■ Body

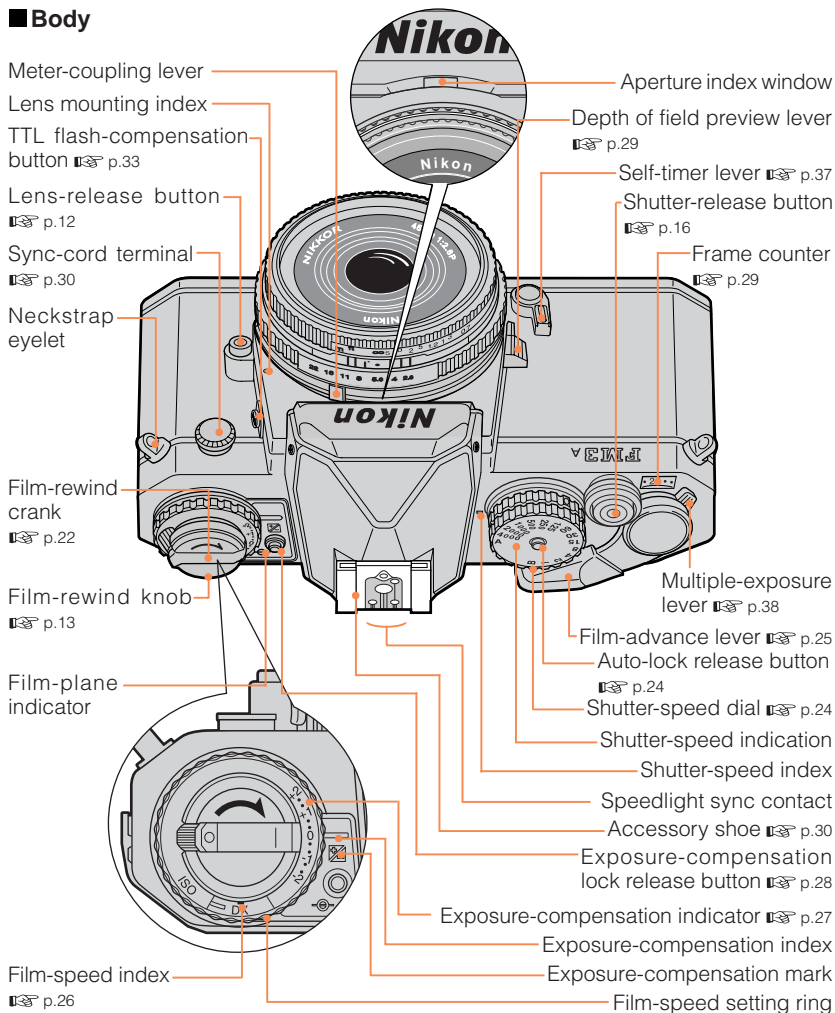

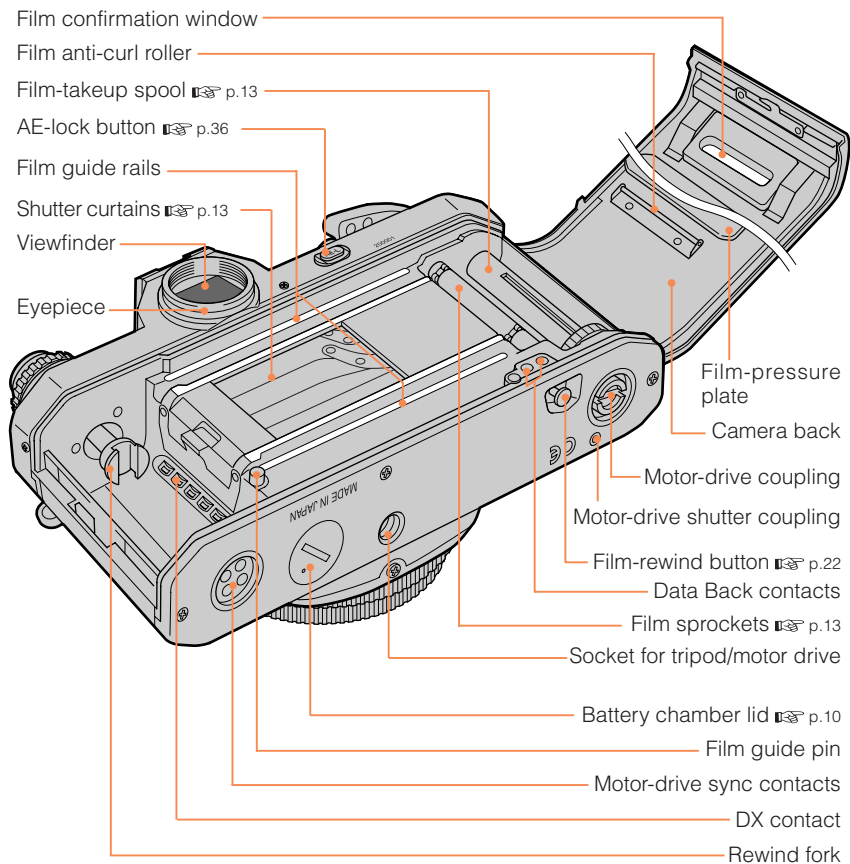

CE About CE marking

CE stands for Conformité Européenne. This marking guarantees that the product meets all applicable EC regulations.

Viewfinder indications

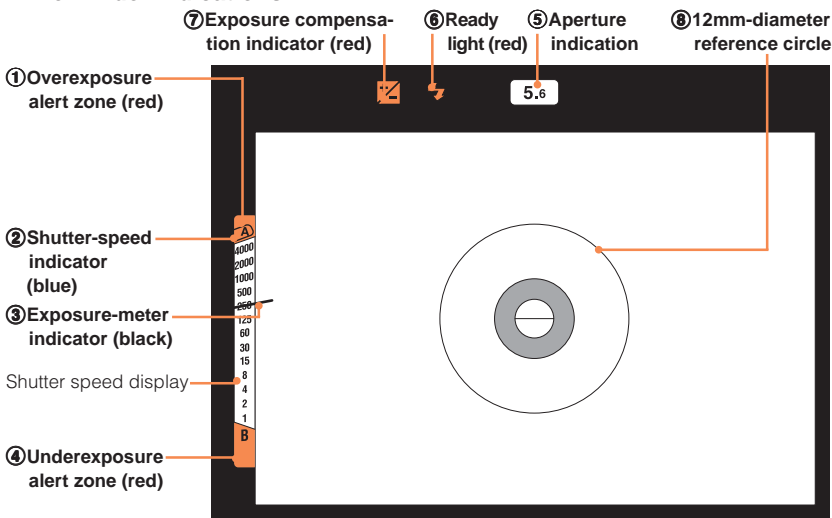

① ④ Overexposure/underexposure alert zone

This is the alert zone, which indicates that the shutter speed is out of range and will result in over/under exposure. Change the aperture setting and/or shutter speed so that the exposure meter indicator does not fall into this zone.

② Shutter-speed indicator

Moves synchronously as you turn the shutter-speed dial. For example, if you set the shutter-speed dial to "A," the shutter-speed indicator points to "A." In Manual mode, it points to the selected shutter speed.

③ Exposure-meter indicator

With a light press of the shutter-release button, power is supplied to the exposure meter and the indicator (needle) swings according to the brightness of the subject and the aperture setting, and indicates the correct shutter speed. When the shutter-speed dial is on "B,"

the needle will not move.

⑤ Aperture indication

The current lens aperture setting is indicated.

⑥ Ready light (p. 32)

⑦ Exposure-compensation indicator

Lights if you perform exposure compensation. (Remember to return the exposure compensation dial to "0" after shooting.)

⑧ 12mm-diameter reference circle

The exposure meter of this camera employs a center-weighted metering system. You can obtain proper exposure by metering the light with the main portion of your subject located within the center 12mm-diameter circle in the viewfinder.

Note: The background of the shutter speed display in the viewfinder is shown white in this manual to clearly show the shutter speeds and indicators, but it is actually transparent and you can see the picture.

Basic Operations for Shooting

- In aperture-priority auto exposure shooting, select the aperture setting appropriate to your desired result. ( p.18)

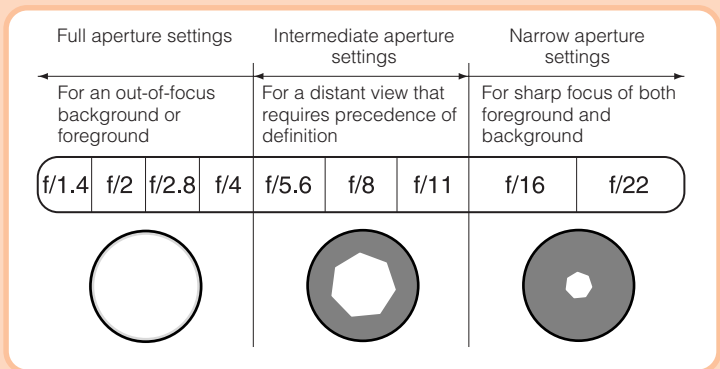

- In manual exposure shooting, you can freeze a moving subject by using a high shutter speed, or you can accentuate the flow of water by using a low shutter speed. With skillful use of shutter speed and aperture, you can obtain the desired effect in your photographs. ( p.20)

Installing Batteries

Tips

Three types of batteries can be used with this camera.

- 1) One 3V lithium battery (CR-1/3N type)
- 2) Two 1.55V silver-oxide batteries (SR44 type)
- 3) Two 1.5V alkaline batteries (LR44 type)

... Use new batteries of the same type when you use two batteries.

1 Remove the battery chamber lid.

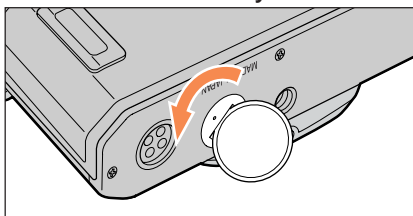

... Use a coin or equivalent to unscrew the lid counterclockwise.

2 Install the battery (batteries).

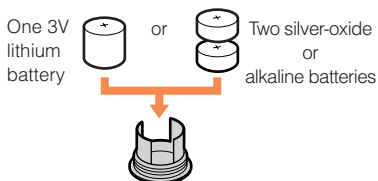

... Make sure that the ⊕ pole faces upward.

3 Return the battery chamber lid to its closed position.

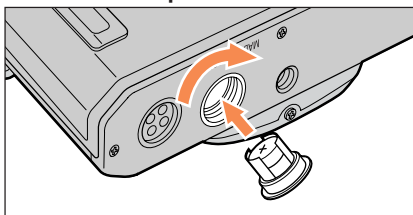

Checking the Battery Power

Check the battery power after installing a new battery (or new batteries) before starting shootings.

- 1** Pull out the film-advance lever ① and lightly press the shutter-release button ② .

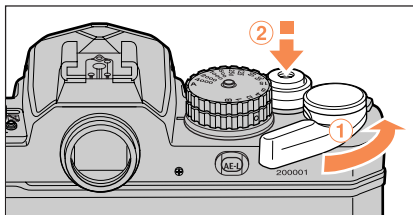

... Pressing the shutter-release button lightly and stopping it halfway is called a “**Light press.**” The power is turned on and the exposure meter is activated when you pull the film-advance lever out to the standoff position and lightly press the shutter-release button.



- When the shutter-speed dial is set to the “B” position, the exposure meter is not activated. Be sure to set the dial to another position.
- If the exposure-meter needle stops moving while the camera is being used, set the shutter-speed dial to the “B” position first and then change to another position. Make sure that the exposure-meter needle is moving.
- If you load non-DX-coded film with the film-speed index set to **[DX]**, or if no film is loaded, the exposure-compensation indicator and the ready light blink alternately as a warning. (☞ p.15)

■ Reference for battery replacement

- 1) Replace the battery (or batteries) at the **earliest** opportunity if the exposure-meter needle moves only when you hold the shutter-release button pressed and then falls down at once when you release it.
- 2) Replace the battery (or batteries) **immediately** if the shutter curtains do not open and the mirror stays at the upper position disabling film advance or if there is no change in the viewfinder indications when you press the shutter-release button with the shutter-speed dial set to the “A” position.

... In this case, set the dial to a position other than the “A” position to restore the original state.

- 2** Check that the exposure-meter needle moves in the viewfinder.

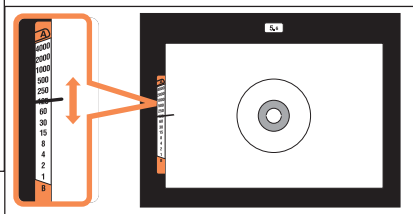

... When battery power is sufficient, the indicator keeps moving for approx. 16 sec. after you take your finger off the shutter-release button.

Attaching/Detaching a Lens

■ Attaching a lens

- 1** Align the mounting index on the lens with the mounting index of the camera body.

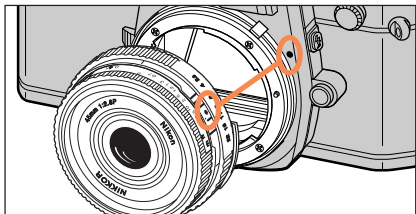

- 2** Insert and twist the lens counter-clockwise (as shown by the arrow).

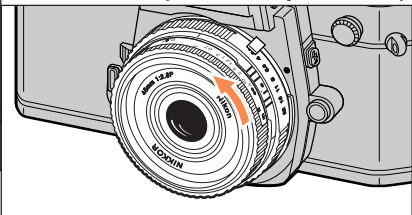

... Twist the lens slowly until it clicks into place.

■ Detaching the lens

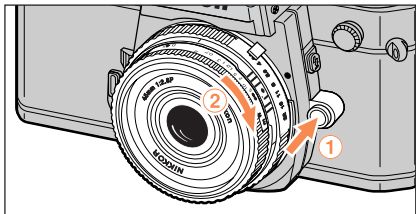

- ... Press and hold the lens-release button ① and twist the lens clockwise ②, (as shown by the arrow) to detach.



- Use an Ai-type lens with this camera. There are some non-Ai-type lenses that can be used with this camera. See page 42 for lens compatibility.
- Avoid direct sunlight when attaching/detaching a lens.
- When attaching a lens, take care not to press the lens release button.
- When you leave the camera unattended without a lens attached, be sure to attach the supplied body cap (page 3), or the optional body cap BF-1A. (The BF-1 body cap for previous models can also be attached.)

Loading Film

Tips

When you use DX-coded film, the camera automatically detects the film speed and makes the appropriate setting.

1 Open the camera back.

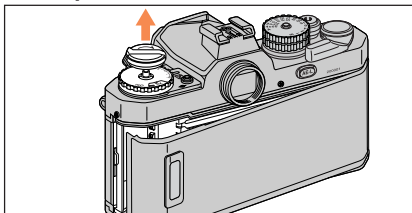

... When you lift the film-rewind knob, the camera back will open.

2 Insert a roll of film ① and push the rewind knob ② back down.

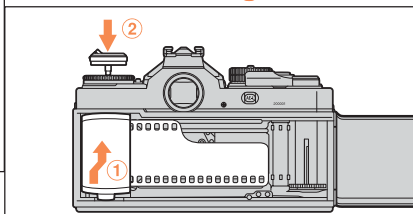

3 Insert the film leader into one of the slots of the film-takeup spool.

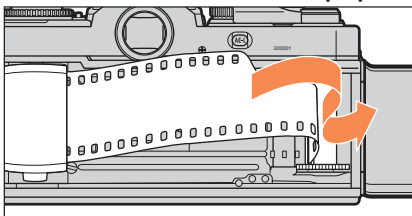

4 Fit the film sprocket holes of the film onto the spool's sprockets.

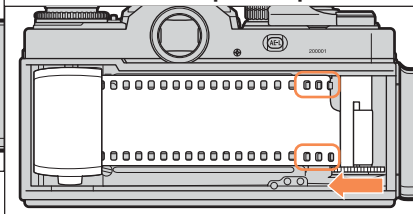

... Slowly rotate the film-takeup spool inward with your thumb, making sure the latch is in the slot such that the film sprocket holes of the film are meshed with the sprockets.

Caution when loading/unloading film

The shutter curtains are very thin. When loading/unloading film, be careful not to touch the shutter curtains with your fingers or the film leader.

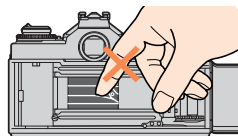

5 Advance the film on the film-takeup spool.

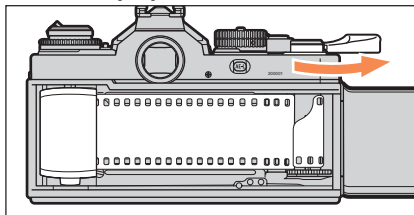

... To advance the film on the film-takeup spool, pull out the film-advance lever to the standoff position and wind it slowly.

6 Check the position of the film.

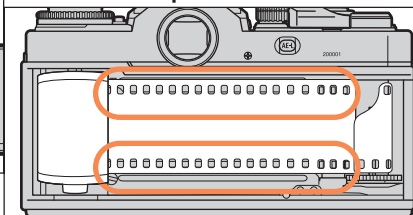

... Make sure that the film sprocket holes are perfectly meshed with the film sprockets and that the film is correctly set between the film guide rails.

7 Close the camera back and take up the film slack.

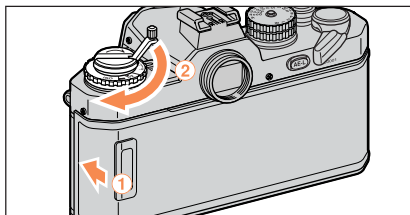

... ① Slowly close the door of the camera back until it snaps shut into the camera body.

... ② Pull out the film-rewind crank and rotate it in the direction of the arrow until it stops to take up the slack inside the film cartridge.

8 Make a few blank exposures.

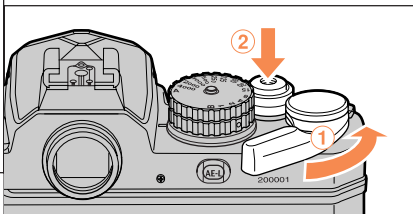

... Wind the film-advance lever ① and press the shutter-release button ② until the frame counter indicates frame 1.

... Adjust the shutter-speed dial to a high speed other than "A."



- If the film-rewind knob fails to rotate when you wind the film-advance lever, reload the film cartridge.
- Repeat making blank exposures until the frame counter indicates frame 1.

Setting the Film Speed (DX-Coded Film)

Tips

When using DX-coded film, set the film-speed index to **DX**. When using non-DX-coded film, set the film speed manually. See page 26.

… When the film-speed index is set to **DX**, the film speed is automatically set (ISO 25 to 5000).

1 Pull up the film-speed setting ring.

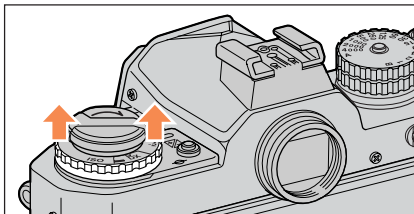

2 Set the film speed to **DX**.

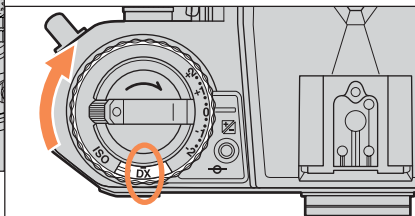

… Turn the ring in the direction of the arrow.



If you load non-DX-coded film with the film-speed index set to **DX**, or if no film is loaded, the exposure-compensation indicator and the ready light blink alternately as a warning.

Film confirmation window

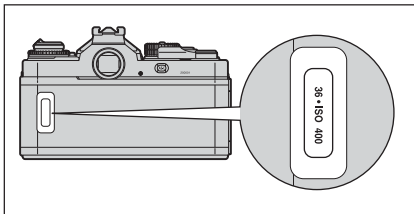

- You can check the film type, the number of frames, and the ISO film speed in the film confirmation window.

Holding the Camera (How to press the shutter-release button)

■ How to hold the camera

Grip the camera in your right hand and look through the viewfinder. Keep your left elbow propped against your body to keep the camera steady.

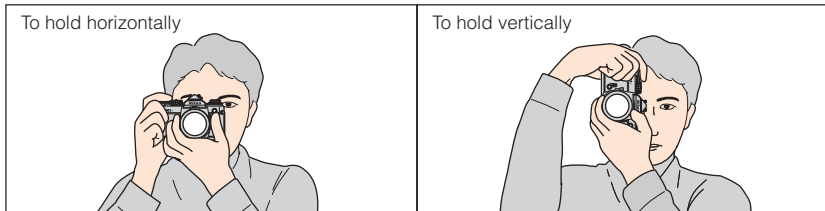

■ How to press the shutter-release button

The shutter-release button of this camera has a 2-step mechanism.

- … Pull out the film-advance lever to the standoff position and press the shutter-release button lightly stopping about halfway. This operation is called a **“Light press.”** The shutter is released when you press the shutter-release button completely down from the lightly-press position.
- … With a “Light press,” the exposure meter turns on, and the meter-on timer is activated. The timer on duration is for approx. 16 seconds from the time you remove your finger from the lightly-pressed shutter-release button, and it is also on for approx. 16 seconds after the shutter is released.

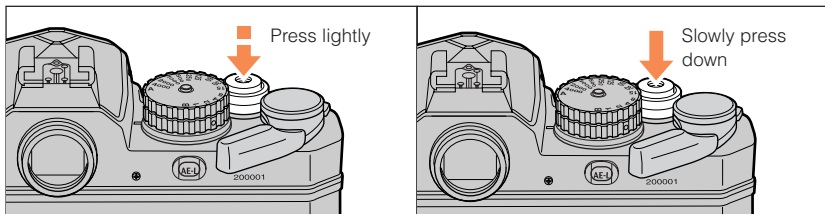

- Moving the camera while pressing the shutter-release button may cause “camera shake” and result in a blurred photograph. Choose a high shutter speed of faster than $1/(\text{focal-length-of-lens})$ second for handheld shooting. Use a tripod and the AR-3 cable release to eliminate camera shake.
- Do not press the shutter-release button abruptly or sharply. Do a “Light press” with the bulb of your index finger, then squeeze to press the button slowly to the end to release the shutter. Pressing abruptly may cause camera shake.
- When the shutter-speed dial is set to “B,” the exposure meter is not activated.

Focusing

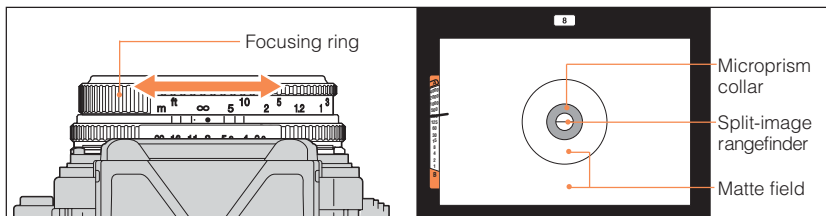

Look through the viewfinder and put the subject in focus by rotating the focusing ring of the lens.

Tips

- To focus using the split-image rangefinder, turn the focusing ring of the lens until the upper and lower images coincide perfectly to form a single unbroken image.

Example: In focus

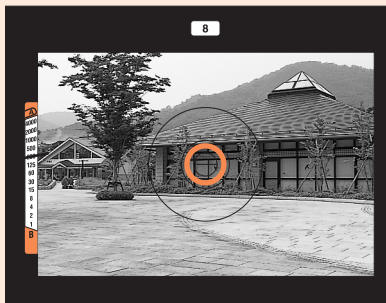

Example: Out of focus

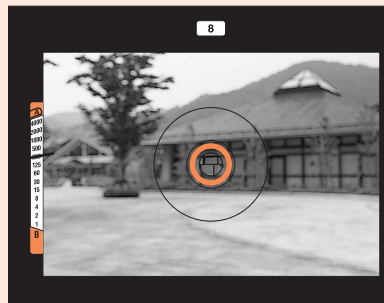

- To focus using the microprism grid or matte, turn the focusing ring so that the fuzzy image becomes sharp.
- Get your main subject in focus.
 - … If you want to photograph a flower, focus on a stamen or pistil, and for an animal or person, focus on the eyes.

Shooting: Aperture-Priority Auto Exposure Mode

Tips

- The aperture setting lets you adjust the exposure and control the depth of field.
 - … If the subject of your picture extends into the distance and/or you want the entire subject to be sharp, choose a narrow aperture setting. If you want an out-of-focus background and/or foreground, select a wide aperture i. e. $f/2.8$. If your subject has little or no depth of field, such as flat wall, choose an intermediate aperture setting.
- In Aperture-Priority Auto Exposure mode, you can make the aperture setting as desired, and the camera controls the shutter speed automatically.

1 Set the shutter-speed dial to “A.”

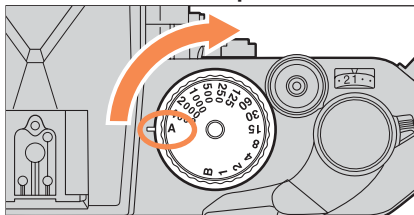

… In the “A” (Auto) position, the shutter-speed dial is locked.

2 Pull out the film-advance lever.

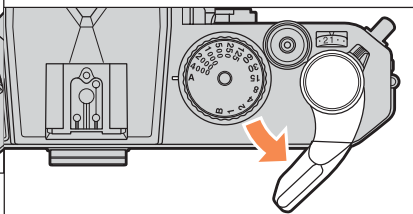

3 Make your lens aperture setting.

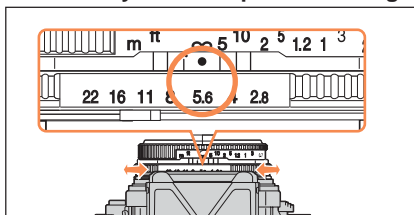

4 Compose your picture and focus.



… Place the main subject inside the 12mm-diameter circle in the center of the screen.

5 Lightly press the shutter-release button.

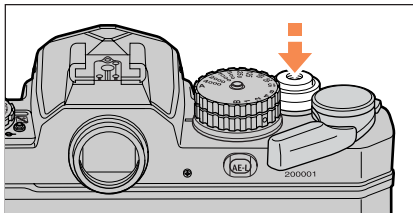

... Check the shutter speed, observing the exposure-meter indication in the viewfinder.

6 Slowly depress the shutter-release button all the way.



... If the exposure meter indication is between 1/60 and 1/4000 second, squeeze to press the shutter-release button all the way.

Tips

- If the exposure-meter needle points in the 1 to 1/(focal-length of the lens) second range:
 - ... Camera shake may occur because the shutter speed is low. Use a tripod or flash.
- If the exposure-meter needle points to the upper alert zone:
 - ... Make a narrower aperture setting. If the indication is still in the alert zone, use an ND filter.
- If the exposure-meter needle points to the lower alert zone:
 - ... Select a wider aperture setting. If the indication is still in the alert zone, use flash photography.

Example: Aperture of f/2.8



Example: Aperture of f/16



Shooting: Manual Exposure Mode

Tips

- In this mode, you can manually select both the shutter speed and the aperture setting as desired.
- By changing the combination of shutter speed and aperture setting, you can change the photo effect without changing the exposure.
- You can create various effects, like controlling the depth of field by varying the aperture setting or freezing the motion of a fast-moving subject with high shutter speed.
- When the battery power is completely exhausted or diminished in a cold place, all the electronic displays are disabled, but major mechanical systems, such as the shutter and aperture control, remain functional, enabling you to continue shooting.

1 Set the shutter-speed dial to a position other than “A.”

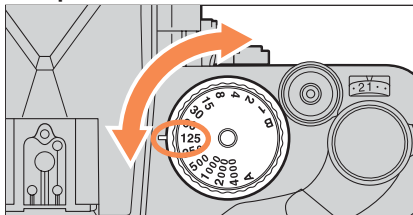

... To change the dial setting from “A,” rotate the dial while holding the auto-lock release button pressed.

2 Pull out the film-advance lever.

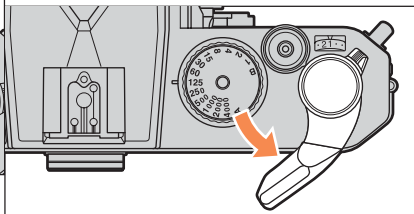

3 Compose your picture and focus.

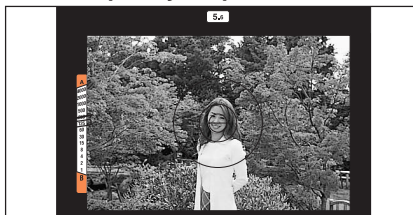

... Place the main subject inside the 12mm-diameter circle in the center of the screen.

4 Lightly press the shutter-release button.

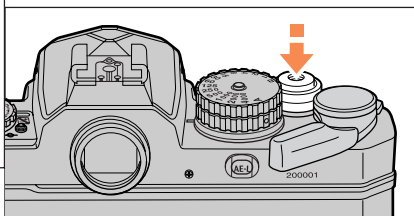

5 Align the shutter-speed indicator and the exposure-meter indicator.

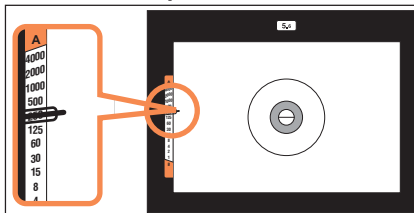

... To align the two indicators, adjust the shutter speed dial and/or the aperture setting.

6 Slowly press the shutter-release button all the way.



Tips

- It is possible to perform exposure compensation by intentionally mismatching the shutter-speed indicator and the exposure-meter indicator.

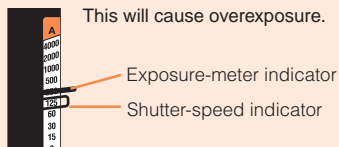
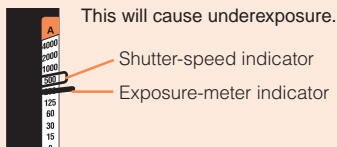

- Reference for shutter speed selection:

- ... If you want to freeze the motion of a fast-moving subject, choose a shutter speed over 1/500.
- ... If you want to create a motion effect by blurring the subject, choose a shutter speed under 1/60.
- ... If you want to accentuate the flow of the water, choose a shutter speed of under 1/15.
- ... If you want to shoot fireworks or tracks of lights at night, choose B.

Example: Shutter speed of 1/15 with aperture of f/16



Example: Shutter speed of 1/500 with aperture of f/2.8



Rewinding the Film

When the end of the roll of film is reached, the film-advance lever will not advance further. Rewind the film.

1 Return the film-advance lever to its folded position.

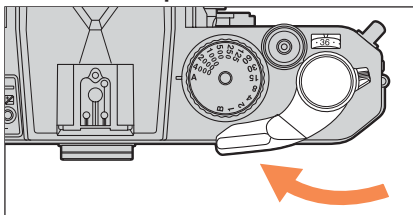

2 Press the film-rewind button.

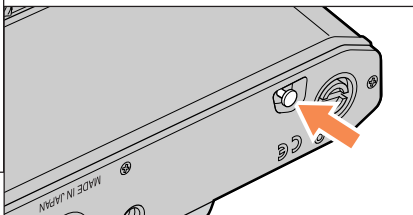

... Just press the button once. You don't have to hold it pressed.

3 Rewind the film.

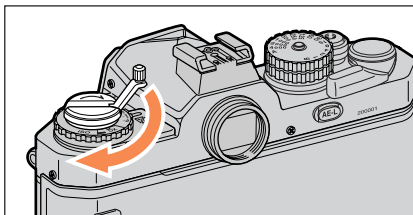

... Pull out the film-rewind crank and turn it in the direction of the arrow.

... As you approach the end of film rewind, you will feel a slight resistance in the crank. Continue turning and stop when resistance to the crank is released and feels lighter.

4 Open the camera back and remove the film cartridge.

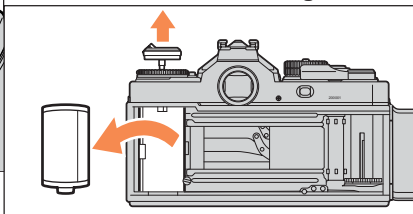

... Pull up the film-rewind knob to open the camera back, and take out the film cartridge.



Do NOT open the camera back until you are sure rewinding is complete.

Controls in Detail

To use the camera skillfully, you need to understand its functions and features.

Shutter-Speed Dial	p. 24
Film-Advance Lever	p. 25
Manual Film-Speed Setting	p. 26
Exposure-Compensation Indicator	p. 27
Frame Counter	p. 29
Depth of Field Preview Lever	p. 29
Film-Plane Indicator	p. 30
Accessory Shoe and Sync-Cord Terminal	p. 30

Shutter-Speed Dial

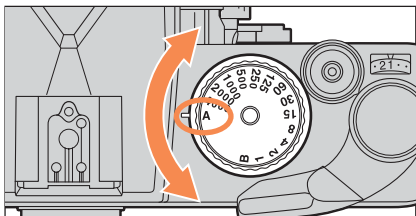

- Depending on the conditions and your intention of shooting, align the shutter-speed index to the figures or marks on the shutter-speed dial. You may choose from among the following shooting modes:

■ A (Aperture-Priority Auto Exposure mode)

Once you make the aperture setting, the camera automatically selects the appropriate shutter speed (stepless control). This is the simplest shooting mode with this camera. ( p.18)

Tips

Locking and releasing the shutter-speed dial:

Once you set the shutter-speed dial to “A,” the dial is locked to prevent inadvertent changes.

… To move the dial to another position, rotate the dial while holding down the auto-lock release button at the center of the dial.

■ 1 to 1/4000 second (Manual mode)

In Manual mode, you can set both the shutter speed and aperture manually to create various creative photographic effects. ( p.20)

■ B (Bulb mode)

In this mode, the shutter stays open as long as the shutter-release button is depressed. Use this function when shooting scenes that require extended exposure (e.g., night time stars, etc.). For very long exposures, use a tripod, and instead of holding the shutter-release button down with your finger, you can lock the shutter release open by using the AR-3 cable release (sold separately), to take steady, long-exposure shots without worrying about “camera shake.”



- You cannot use intermediate positions between shutter-speed dial clicks.
- In B (Bulb) mode, the shutter operation is performed mechanically (not electronically). However, a very small amount of battery power may be drained. Therefore, we recommend you remove the battery to save the battery power when you plan to take many pictures using B mode.

Film-Advance Lever

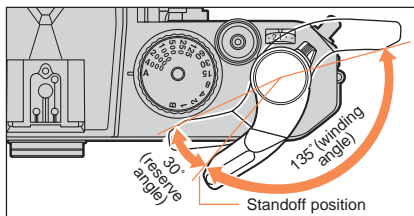

- The film-advance lever also provides a lock function for the shutter-release button.

Tips

Power on/off:

- ... When you pull the film-advance lever to the standoff position and lightly press the shutter-release button, the exposure-meter turns on and the exposure indication appears in the viewfinder.
 - ... When you are not using the camera, keep the film-advance lever set to its home position to prevent the shutter from being inadvertently released.
- ... To advance the film, pull the film-advance lever out to the standoff position, then wind the lever until it stops. This operation advances the film by a single frame, and enables the next shutter release.
- ... The lever stops advancing when the film roll reaches the end. In this case, rewind the film. Do not forcibly advance the lever further or you might damage the film or the camera.



In rare cases the film-advance lever meets strong resistance. If so, the film may have been advanced unevenly. Do not advance it forcibly. Rewind the film.

Manual Film-Speed Setting

Tips

Set the film speed manually in the following cases:

- 1) When using non-DX-coded film.
- 2) To intentionally change the light sensitivity of DX-coded film in order to obtain special effects when developing.

... The film speed can be set manually in the range of ISO 12 to 6400.

■ Setting the film speed

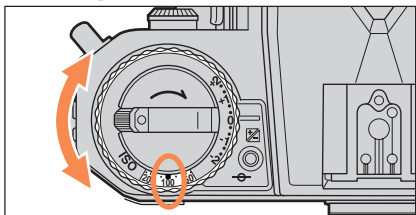

- Pull and rotate the film-speed setting ring and set it to the film speed of the film in use.

■ Details on readings of the film-speed index

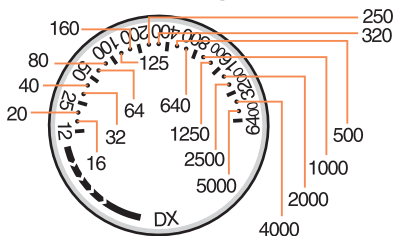

- The corresponding film speeds for the dots between numbers on the film speed index are indicated in the illustration.

Exposure-Compensation Indicator

If there is an extreme difference in brightness between the main subject and the background (e.g., a person surrounded by heavy shadows), it may be difficult to get the correct exposure. In this case, or when you want to achieve a certain effect, exposure compensation is recommended.

Example: Before compensation



... Without exposure compensation, the face is underexposed.

Example: After compensation
(compensated toward the + side)



... With exposure compensation, you get sufficient brightness on the face.

Tips

- A highly reflective or whitish (bright) subject may cause underexposure. In this case, adjust exposure compensation toward the + side. Likewise, when shooting a dark subject with little reflection that might cause overexposure, compensate toward the – side.
- ... If it is hard to decide on the level of compensation, it is best to take the same shot several times with different exposures.

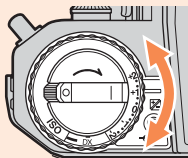

- When exposure compensation is active, the exposure-compensation indicator  appears at the top of the viewfinder.

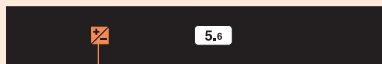

Exposure-compensation indicator

- Remember to return the exposure-compensation indicator to the “0” after shooting.

■ Exposure compensation using the exposure-compensation indicator

It is possible to adjust ± 2 EV in units of $1/3$ EV.

While holding down the expo-
sure-compensation lock release

1 button ①, rotate the film-speed
setting ring ②.

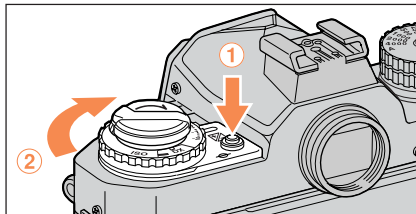

2 Set the compensation index to
the desired compensation value.

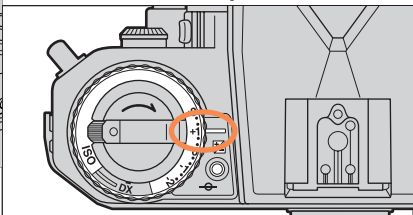

... Confirm the ring is firmly set down and locked
in a clicked position.



When you set the film speed to ISO 12, compensation to the + side is disabled (the setting ring may rotate, but the speed remains at ISO 12). When the film speed is set to ISO 6400, compensation to the - side is disabled. (The setting ring will not rotate further.)

Frame Counter

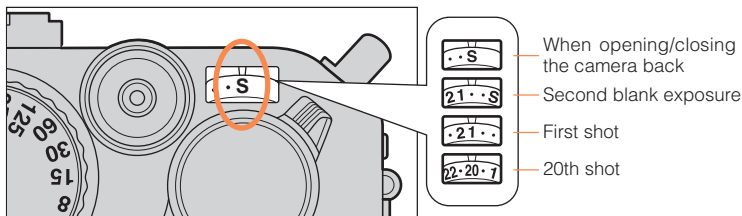

- … The frame counter has indications of S, 1, 2, 4, 6, etc., up to 36 in even numbers. Frames of odd numbers are indicated by dots between the even numbers.
- … The counter stops at 36. However, film will be advanced up to the actual end of the film roll.
- … Even if there is no film in the camera, the frame counter is operative and advances by a single frame every time you wind the advance lever.
- … The frame counter is automatically reset to “S” when the camera back is opened.

Depth of Field Preview Lever

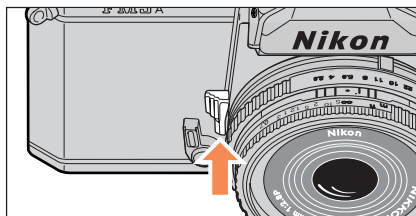

- When you press the depth of field preview lever toward the camera body, the lens is stopped down to the specified aperture setting, enabling you to check the depth of field through the viewfinder.

- … When checking the depth of field with an Ai-type lens attached to the camera, press the depth of field preview lever fully. Release the lever before you shoot.
- … When you press the lever, the image in the viewfinder is darkened according to the specified lens aperture.

Film-Plane Indicator

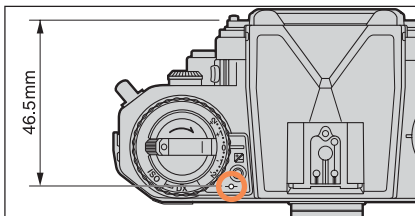

- The  mark shown on the upper panel of the camera indicates the position of the film plane inside the camera.

- … This film-plane indicator can be used as the measurement standard when you must know the actual camera-to-subject distance (e.g. in close-up photography).
- … The exact distance from the lens-mounting flange to the film plane is 46.5mm.

Accessory Shoe and Sync-Cord Terminal

■ Accessory Shoe

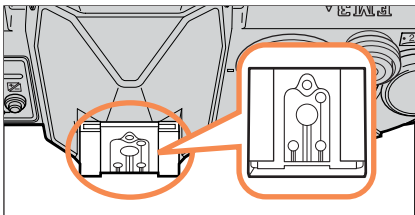

- A Nikon cordless-type speedlight can only be connected by attaching it to the accessory shoe.
- This accessory shoe is equipped with a safety lock mechanism (a lock hole) to prevent slippage.

■ Sync-Cord Terminal

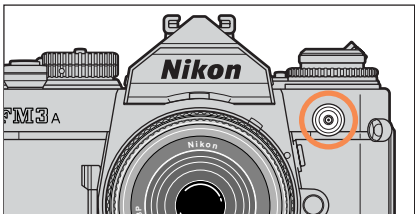

- This camera has a sync-cord terminal (with a screw to prevent slippage). To use a sync-cord, connect it to this sync-cord terminal ("X" contact only available as sync contact).

Steps of Advanced Photography

With the convenient features of Auto Exposure mode, you can obtain great results with easy shooting. However, we hope you will also learn more advanced photographic techniques to take full advantage of the wonderful capabilities of your Nikon FM3A camera.

Flash Photography	p. 32
AE-Lock Photography	p. 36
Self-Timer Photography	p. 37
Multiple-Exposure Photography	p. 38

Flash Photography

Flash photography is not only useful when shooting in a dark place. Even in daylight shooting, it is sometimes useful to use the flash for supplementary lighting to increase the shooting range, such as when the subject is too dark because of rear lighting or a bright background.

■ Applicable speedlight and shooting situation

Speedlight model	Valid shooting modes			Connection method
	TTL flash	Non-TTL (external) auto flash	Manual flash	
SB-80DX, SB-30, SB-28/28DX, SB-27, SB-26, SB-25, SB-24	yes	yes	yes	Cordless
SB-50DX, SB-29/29s, SB-23, SB-21B	yes	no	yes	Cordless
SB-22/22s, SB-20, SB-16B, SB-15	yes	yes	yes	Cordless
SB-11, SB-14, SB-140	yes	yes	yes	*1, *2

*1 TTL Auto Flash is possible with TTL Remote Cord SC-23.

*2 When you shoot in "A" or "M" mode on the speedlight:

- use the SU-2 in combination with the SC-13 to connect the SB-11 or SB-14.
- use the SU-3 in combination with the SC-13 to connect the SB-140.
- use the AS-15 in combination with the SC-11 or SC-15 to connect the SB-140.



If the speedlight flash battery power is low or exhausted, the ready light on the speedlight flash turns on earlier than that in the viewfinder. In this case, replace the speedlight flash batteries with new ones.

■ Ready Light flash status

The ready light is built into the viewfinder and enables you to check the status of the speedlight while looking through the viewfinder.

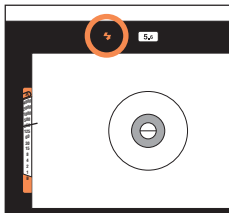

Lit: The ready light turns on when the speedlight is fully charged and ready to flash.



...The ready light does not light in Bulb mode or if the camera's battery power is fully exhausted.

Blink: After taking a picture, the ready light blinks for approx. 3 seconds as a warning if underexposure is likely with the full-flash output of the speedlight. In this case, shoot again after checking the focus distance, aperture setting, range of flash shooting distance, etc.



... The ready light will also blink as a warning if the shutter speed is set between 1/500 and 1/4000 second. Select a shutter speed below 1/250 second.

■ TTL flash

With the TTL flash system, the camera measures the flash of a speedlight reflected from the subject to obtain the proper level of flash illumination.

■ TTL flash-exposure compensation

Example: Before compensation



Example: After compensation



In flash photography when the main subject is far away or near the edge of the viewfinder frame, overexposure may occur, as the reflected light may be insufficient. This may cause excessive flash illumination. Flash photography with a bright background may also give unnatural results.

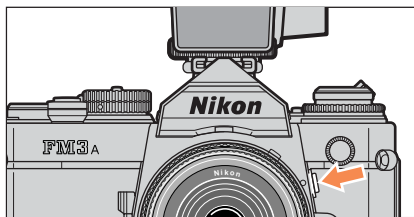

In such a situation, shooting with the TTL flash-compensation button held pressed can automatically reduce the level of flash illumination for more natural and better exposure results.

When the TTL flash-compensation button is used, the illumination of the speedlight is automatically **compensated (reduced) by 1 EV to the – side.**



- There is no indication regarding the flash-exposure compensation when you press the TTL flash-compensation button.
- If exposure compensation is made by the camera, the level of flash illumination is controlled by adding this compensation level.
- The flash-exposure compensation function of the speedlight is disabled in TTL mode.

■ Procedure for TTL flash photography

Tips

- Applicable film speeds for TTL auto flash are ISO 12 to ISO 1000.
 - The flash-sync speed is 1/250 second or lower. In Aperture-Priority Auto Exposure mode, the speed is automatically set to 1/250 second.
- ... When you use a Medical lens, set it to 1/125 second or lower.

The following example shows the Nikon SB-27 Speedlight attached to the camera. For details, refer to the manual for your speedlight.

1 Set the exposure mode.

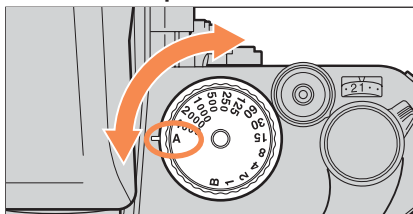

- ... Set to A. Or, set to a shutter speed of 1 to 1/250 second.

2 Set the mode switch of the speedlight to AUTO.

(Example: with SB-27)

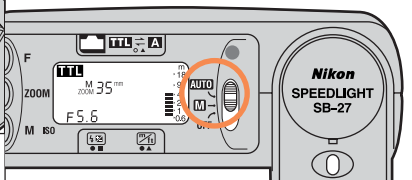

3 Confirm that the ⚡ mark lights in the viewfinder.

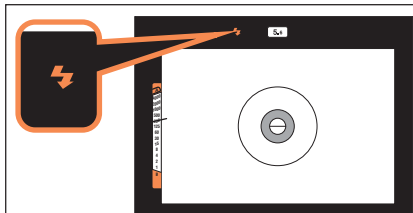

- ... Lightly press the shutter-release button and check the ready light.

4 Compose your picture and focus.

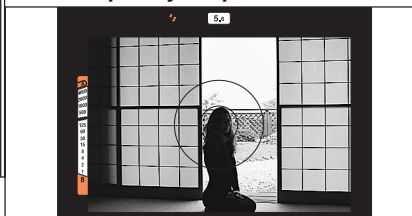

5 Make sure the subject is within the range of flash-shooting distance, then shoot.

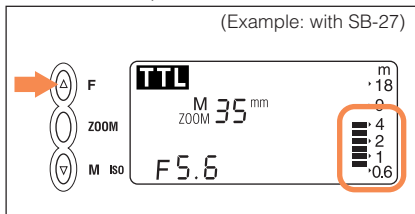

- ... Press the F button to obtain the same value as the aperture setting on the lens.
- ... Lightly press the shutter release button and check that the ready light is lit, then shoot.

Tips

<ISO 100>

- Equation to obtain the camera-to-subject distance:
 $D \text{ (distance to subject)} = GN \text{ (guide number)} / f \text{ (aperture)}$
- Equation to obtain the aperture:
 $f \text{ (aperture)} = GN \text{ (guide number)} / D \text{ (distance to subject)}$



If the ready light blinks for approx. 3 sec. immediately after firing the flash, check the camera-to-subject distance, aperture setting, and range of flash-shooting distance, and shoot again.



Flash attachments from other manufacturers

- NEVER use a flash attachment from another manufacturer. The full performance of this camera can only be obtained with Nikon brand accessories. Other brands may apply a voltage of ISO 24V or higher to the camera's "X" contacts, or otherwise short-circuit the accessory-shoe contacts, resulting in damage to the circuits in the camera.
- Before using the Speedlight, make sure that the Speedlight flash flashes when the shutter is released.

AE-Lock Photography

Tips

- AE-lock photography is possible in Aperture-Priority Auto Exposure mode. You cannot use it in Manual Exposure mode.
- Since the composition of a shot can be changed with the EV temporarily stored in memory, AE-lock photography of a subject of normal (intermediate) brightness proves to be highly effective when back lighting is present that makes it difficult to specify the exposure, or when subjects of high and low reflectance are intermingled in the viewfinder.

1 Locate the subject in the center of the viewfinder and focus.

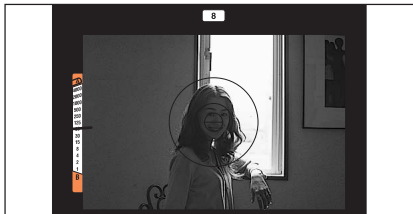

2 Lightly press the shutter-release button.

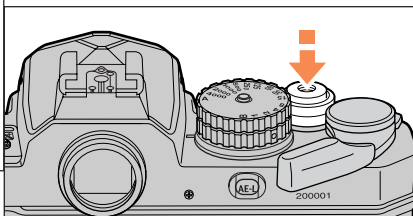

3 Press the AE-lock button.

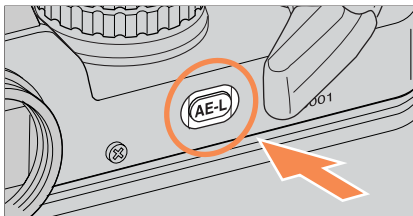

4 Compose your shot, and shoot with the AE-lock button held pressed.

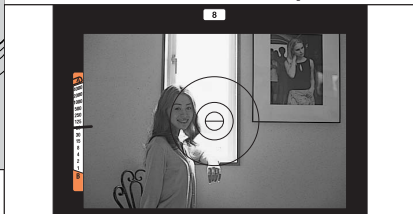

- Apply the auto exposure lock when the exposure meter is active.
- The exposure-meter indicator in the viewfinder is fixed in AE-Lock mode.

Self-Timer Photography

Tips

The self-timer is useful when you want to include yourself in a group shot or to prevent camera shake.

... The maximum count-down time of the self-timer is approx. 10 seconds.

1 Pull the self-timer lever in the direction of the arrow.

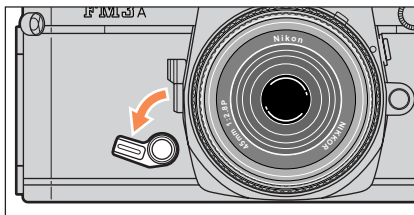

2 Check the focus and exposure, then shoot.

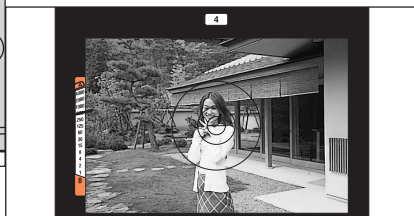

... The shutter is released with a delay of approx. 10 seconds.

... The countdown time of the self-timer can be set from 4 to 10 seconds, according to how far you cock the self-timer lever.



- You can cancel self-timer operation after you set it. To cancel, pull the lever back toward the lens completely until it stops before you press the shutter-release button. (If you pull the self-timer lever back when it is already in operation, the shutter is released the moment the lever reaches its original position.)
- When you shoot without looking through the viewfinder in Aperture-Priority Auto Exposure mode, cover the eyepiece to prevent interference from stray light when you press the shutter-release button.

Multiple-Exposure Photography

Tips

- Exposing a single frame more than once to overlap multiple images is called multiple-exposure photography.
- If images are to be overlapped in the background, exposure compensation is required, depending on the number of exposures in multiple-exposure photography. (When images do not overlap, no compensation is necessary.)

Number of exposures	2	3	4	8 or 9
Standard compensation value	- 1.0 EV	- 1.5 EV	- 2.0 EV	- 3.0 EV

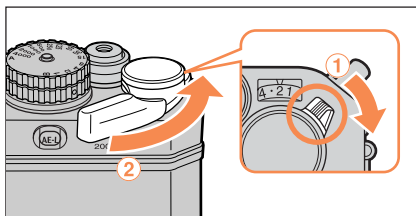

- Do not advance film for multiple-exposure photography, wind the film-advance lever **2** while holding the multiple-exposure lever **1** toward you.

... As the film does not advance, the frame counter does not count up.



Frames may shift slightly in some cases of multiple-exposure photography. In particular, film advance may be slightly unstable at the beginning and end of a roll, so multiple-exposure photography using the first or last frame of a film roll is not recommended.



Additional Information

Keeping this information in mind may help you avoid problems.

In particular, do not forget to read “Tips on Handling the Camera and Batteries” on page 48.

Shutter Speed and Aperture Setting

The shutter-speed setting specifies the length of time the film will be exposed by opening and closing of the shutter curtains, while the aperture setting determines the amount of light that passes through the lens. The combined value of these settings is called EV (Exposure Value).

For example: using ISO100 film with a shutter speed of one second and an aperture setting of $f/1.0$, the EV is defined as 0 (EV 0). This value increases by one each time the aperture is stopped down or the shutter speed is increased by one unit.

The shutter speed and the aperture value converted from the EV are displayed in the viewfinder of the camera. The same EV can result from various possible combinations of shutter speed and aperture setting. For example, as shown in the EV table below, when the correct exposure is obtained with a shutter speed of $1/125$ second and an aperture setting of $f/11$ (EV14), you can obtain the same amount of light also at $1/60$ second and $f/16$ or at $1/250$ second and $f/8$, for the correct exposure. Understanding these combinations, you can change only the effect on the picture by changing the combination of shutter speed and aperture setting without changing the exposure value.

Tips

Priority should be given to shutter speed when movement is more important, and to the aperture setting when depth of field is more important.

Exposure Values

when using ISO100 film

Aperture setting (f) \ Shutter speed (sec)	1.0	1.4	2	2.8	4	5.6	8	11	16	22	32
8	-3	-2	-1	0	1	2	3	4	5	6	7
4	-2	-1	0	1	2	3	4	5	6	7	8
2	-1	0	1	2	3	4	5	6	7	8	9
1	0	1	2	3	4	5	6	7	8	9	10
1/2	1	2	3	4	5	6	7	8	9	10	11
1/4	2	3	4	5	6	7	8	9	10	11	12
1/8	3	4	5	6	7	8	9	10	11	12	13
1/15	4	5	6	7	8	9	10	11	12	13	14
1/30	5	6	7	8	9	10	11	12	13	14	15
1/60	6	7	8	9	10	11	12	13	14	15	16
1/125	7	8	9	10	11	12	13	14	15	16	17
1/250	8	9	10	11	12	13	14	15	16	17	18
1/500	9	10	11	12	13	14	15	16	17	18	19
1/1000	10	11	12	13	14	15	16	17	18	19	20
1/2000	11	12	13	14	15	16	17	18	19	20	21
1/4000	12	13	14	15	16	17	18	19	20	21	22

Depth of Field

When you focus on your subject, you will find that not only is the subject itself in focus but objects in a certain distance range both in front of and behind the subject appear reasonably sharp. This in-focus zone is known as “depth of field.”

Control of depth of field enables selective blurring of the background elements of a picture or letting the major subject stand out.

By pressing the depth of field preview lever, you can check how the background image will appear in the photograph.

Tips

- The depth of field changes depending on three factors; aperture, focal length of the lens, and shooting distance as follows.
 - 1) The wider the aperture opening, the shallower the depth of field, and the narrower the aperture opening, the deeper the depth of field.
 - 2) The longer the focal length (such as with a telephoto lens), the shallower the depth of field, and the shorter the focal length (as with a wideangle lens), the deeper the depth of field.
 - 3) The closer the subject is to the lens, the shallower the depth of field, and the farther away the subject is from the lens, the deeper the depth of field.
- Controlling the depth of field gives your picture its own character.

Light-Metering Methods

■ Full-aperture metering

With a built-in sensor, this camera employs TTL full-aperture metering to determine the exposure by measuring the brightness of subjects through the lens. With an Ai-type lens attached, full-aperture metering is performed, and you can set the exposure while maintaining full brightness in the viewfinder.

■ Stop-down metering

This method is used when the meter coupling lever does not operate in synchronization with the lens aperture.

With this method, after making the aperture setting for actual shooting, the light is measured when a Non-Ai-type lens or close-up ring is used.

Lens Compatibility

Any of the following lenses can be used with this camera.

Exposure mode Lens	Aperture-priority auto	Manual	Remarks
CPU lens <ul style="list-style-type: none"> • D-type AF • Non-D-type AF • Ai-P • PC Micro 85mm f/2.8D 	yes*1	yes*1	
Non CPU lens <ul style="list-style-type: none"> • Ai-S • Ai / Ai-modified • Series E 	yes	yes	
Medical 120mm f/4	no	yes*2	Stop-down metering
Reflex lenses	yes	yes	
PC lenses	yes*3	yes*4	Stop-down metering
PB-6 Bellows Focusing Attachment	yes*5	yes	Stop-down metering
IX lenses G-type lenses	no	no	

*1: When using the PC Micro 85mm f/2.8D, only manual exposure can be used. Note, however, that the exposure-meter indication will not be correct if you shift and/or tilt the camera or if you have an aperture setting other than full aperture. In addition, the TTL flash and the flash compensation will not work.

*2: Only manual exposure is enabled and is usable with shutter speeds under 1/125 second.

*3: In aperture-priority auto exposure, first preset the aperture on the lens, then shift and/or tilt the camera.

*4: In manual exposure, first preset the aperture on the lens, then measure the light to determine the exposure before shifting and/or tilting the camera.

*5: First make the aperture setting for the bellows focusing attachment, then measure the light and shoot.

Note that the following lenses and accessories cannot be attached to this camera. (If you try to forcibly attach them, the camera and/or lens may be damaged.)

- Non-Ai-type lenses
- TC-16A Teleconverter
- Lenses used with the AU-1 Focusing Unit (400mm f/4.5, 600mm f/5.6, 800mm f/8, and 1200mm f/11)
- Fisheye lenses (6mm f/5.6, 8mm f/8 and OP 10mm f/5.6)
- Old-type 21mm f/4
- K2 ring
- ED 180-600mm f/8 (Product No. 174041-174180)
- ED 360-1200mm f/11 (Product No. 174031-174127)
- 200-600mm f/9.5 (Product No. 280001-300490)
- 80mm f/2.8, 200mm f/3.5, and TC-16 Teleconverter for F3AF
- PC 28mm f/4 (Product No. 180900 or smaller)
- PC 35mm f/2.8 (Product No. 851001-906200)
- Old-type PC 35mm f/3.5
- Old-type Reflex 1000mm f/6.3
- Reflex 1000mm f/11 (No. 142361-143000)
- Reflex 2000mm f/11 (No. 200111-200310)

Tips

How to distinguish Ai-type lenses from non-Ai-type lenses

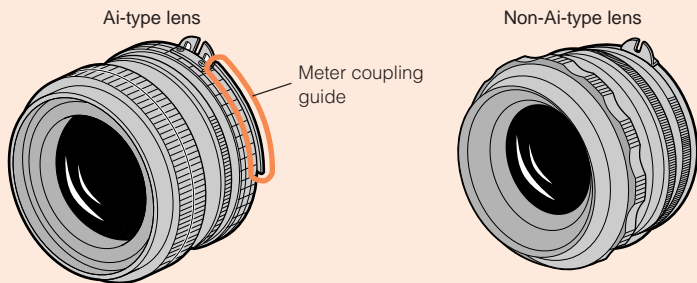

An Ai-type lens has a meter-coupling guide, but a non-Ai-type lens does not.

Optional Accessories

■ Lenses

45mm f/2.8P Lens

- Top quality and unique design with metallic silver or black appearance is an ideal combination with the FM3A camera.
- Lightweight and superthin lens of 17mm (0.7 in.) total length, optimum as a regular-use lens.
- The minimum shooting distance is as close as 45cm (17.7 in.).
- While being a manual-only lens, it can provide all exposure modes with the built-in CPU, enabling use with an auto-focus camera.

A wide variety of lenses — 14mm to 1000mm; wideangle, telephoto, zoom, Micro or DC (Defocus image Control) — is available for the FM3A.



■ MD-12 Motor Drive

With the MD-12 motor drive attached to the bottom of the camera body, automatic film advance and continuous shooting at a maximum rate of approx. 3.2 frames per second are enabled.

This proves very convenient when shooting fast-moving subjects.

■ SB-27 Speedlight

- A compact, lightweight flash attachment that enables TTL light metering, external automatic light metering, and manual flash firing.
- The mounting position of the light-emission block can be changed to horizontal at the right, and vertical, or horizontal at the left, so that you can easily control the shadow of the subject.
- The built-in reflective plate enables you to bounce flash upward or to the left.
- The catch-light effect (to reflect part of flash on eyes) and the diffuser (to soften the flash) allow additional effects for close-up photography.
- The SB-80DX, SB-50DX, SB-30, SB-29s, SB-28, SB-23, and SB-22s are also available.

■ MF-16 Data Back

- By attaching the MF-16 to this camera, you can superimpose any of the following: year/month/day, day/hour/minute, or the frame number.
- The alarm function can be set to sound a buzzer at a specified time.
- The MF-16 also operates in synchronization with the MD-12 motor drive when attached.

■ Camera Case

- The CF-27S, CF-28S, and CF-29S semi-soft cases are available.
- The CF-27S case accommodates the camera with a mounted lens of 50mm f/1.4 or smaller. The CF-28S case accommodates the camera with a mounted lens between 50mm f/1.2 and 135mm f/2.8.
- When the MD-12 motor drive is attached to the camera, use the CF-29S. In addition, the CF-28A front cover for a 35-70mm zoom lens is available.

■ Filters

- Nikon filters are divided into three types: screw-on, drop-in and rear-interchange. With the FM3A, the filter factor need not be considered except with the R60 filter. Compensate exposure +1 EV when using the R60.
- For a filter to protect the lens, use of an L37C or NC filter is recommended.
- Moiré may occur when shooting a subject against bright light or if a bright light source is in the frame. In this case, remove the filter before shooting.

■ Neck straps

The leather AN-1 (black), the mesh-type AN-4Y (yellow) and AN-4B (black), and the wide AN-6Y (yellow) and AN-6W (wine red) are available.

■ Others

AR-3 Cable release

A screw-in type cable release is available so that you can eliminate camera shake caused by pressing the shutter-release button. This also enables you to lock the shutter-release button in Bulb mode without holding the button pressed with your finger.

DK-3 Eyepiece attachment

When attached to the camera's eyepiece, this makes the field of vision in the viewfinder clearer, and may reduce eye strain. The DK-3 is made of rubber.

Eyepiece correction lens (for dioptre adjustment)

For nearsighted or farsighted photographers. This eyepiece can be easily attached just by screwing it onto the camera's eyepiece. Nine models (-5, -4, -3, -2, 0, +0.5, +1, +2, or +3) are available. It is recommended to try them before purchasing, as proper dioptre greatly differs among individuals.

DB-2 Anti-cold battery pack

When you keep the DB-2 external power supply for the camera body in your pocket, power is steadily supplied even when the ambient temperature is low. (AA-type NiCd, NiMH and Lithium batteries cannot be used for this battery pack. When the DB-2 battery pack is mounted to the camera, tripod cannot be used.)

DG-2 Eyepiece Magnifier

When attached to the viewfinder eyepiece, this accessory enlarges the image at the center of the viewfinder to assure precise focusing in close-up photography, duplication work and telephotography.

DR-4 Right-Angle Viewing Attachment

Screws onto the viewfinder eyepiece to provide a viewfinder image at a 90° angle to the camera's optical axis. An Adapter Ring DK-13 (optional) is required.

Changing the Focusing Screen

Tips

- Different types of focusing screens can be used with this camera. The K3-type Clear Matte screen IIa comes with the camera as a standard accessory.
- Two types of screen are available for replacement as options: B3 type and E3 type. Select the one that matches your particular requirements.

- 1** Pull the focusing screen release latch ① towards you using the special tweezers ②.

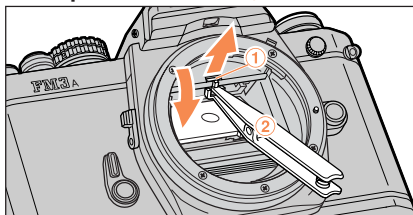

- ... The focusing screen comes down.
- ... The special tweezers are supplied with a focusing screen for replacement.

- 2** Grip the screen by pinching the tab of the screen and remove it.

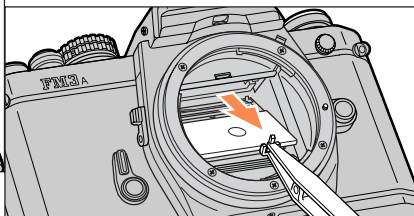

- 3** Place the replacement screen on the screen holder.

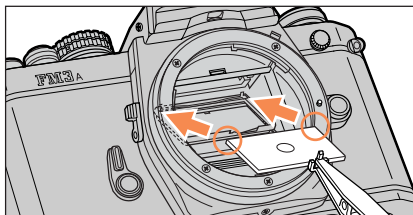

- ... Be sure to place the screen in the right position on the holder.

- 4** Push the front edge of the holder upward to secure the screen.

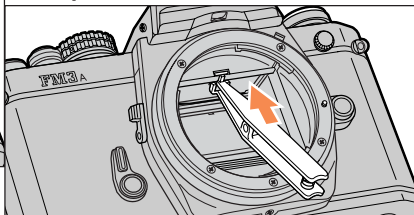

- ... Push up on the holder until it snaps into place.

Tips

How to distinguish the applicable types.

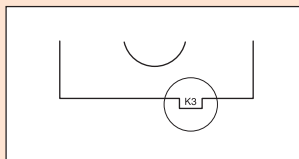

K3 type, B3 type, E3 type

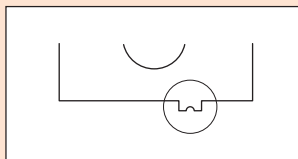

K2 type, B2 type, E2 type
(for New FM2 and FE2)

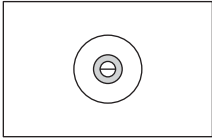
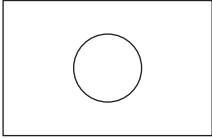
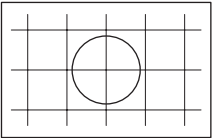
Type	Name/style	Features
K3	Split-image rangefinder/ microprism system 	Suitable for general photography. It has a microprism collar around the central split-image rangefinder spot. With a PC lenses or lenses having a maximum aperture less than $f/4.5$, the split-image rangefinder or microprism collar is dim. In this case, focus on the surrounding matte area.
B3	Matte system 	Works well for general photography, close-up photography, and duplication work. Especially useful for people who prefer to focus on the matte focusing spot at the center of the screen, or when it is inconvenient to use the split-image rangefinder for focusing, as is the case with telephoto lenses.
E3	Etched system with horizontal and vertical lines 	Extremely useful in pictorial composition. It consists of a B3-type matte field with etched horizontal and vertical lines. Also useful with PC lenses.

... K2, B2 and E2 types for the FE2 or New FM2 can be used with this camera without exposure compensation. K3, B3, and E3 type for this camera can be used with an FE2 or New FM2 camera, no compensation is required.

Tips on Handling the Camera and Batteries

■ Camera Care



WARNING



Do NOT use thinner, benzene or other organic solvents to clean the camera.

They may damage the camera, cause it to catch fire, or harm your health.

• **Cleaning the camera**

First lightly blow off dirt and dust with a blower, then gently wipe the body with a clean soft cloth. After using the camera near sea water, wipe the body with a soft cloth slightly moistened with tap water to remove salt, then lightly wipe it with a dry cloth.

• **Cleaning the mirror and lens**

The mirror and lens are very sensitive. Clean them only by lightly blowing off dust with a blower.

If the lens is smeared, such as with fingerprints, gently wipe it with a clean, soft cloth moistened with commercially available lens cleaner.

• **Do NOT subject the camera or lens to strong shock.**

Be careful not to drop the camera and lens or hit them against a hard surface.

Such strong shock may damage the camera or badly affect the precisely adjusted parts.

• **Do NOT touch the shutter curtains.**

The shutter curtains are made of a very thin material. NEVER hold, push, or strongly blow with a blower. Such actions can crack, deform, or damage the curtains.

• **Avoid locations where strong radio waves or strong electromagnetic fields are generated.**

The camera may not operate correctly in a location where a strong radio wave or strong electromagnetic field is generated, such as near a television tower.

• **Store the camera in a cool, dry, well-ventilated place.**

To eliminate mold and damage, store the camera in a dry place with sufficient ventilation.

- Do NOT leave the camera in a place exposed to chemicals such as camphor or naphthalene, near equipment generating a strong magnetic emission, or in an excessively hot place, such as inside a car or in front of a heater.

• **Avoid extreme temperature changes.**

Extreme temperature changes can cause condensation outside and inside the camera. When taking the camera to very hot place from a cold place or vice versa, place it inside an airtight container such as a plastic bag and leave it inside awhile to expose the camera gradually to the temperature change.

- **Remove the battery (batteries) and store the camera with a desiccant.**

If you do not intend to use the camera for a long time, store it after removing the battery (batteries) to protect the camera from battery leakage.

- When storing the camera, it is recommended to store it with a desiccant in a plastic bag. Note, however, that storing the leather camera cases in plastic bags may cause the leather to deteriorate. Keep the batteries in a cool, dry place.
- A desiccant will lose its effect after absorbing a certain amount of moisture. Occasionally replace it with new one.
- Leaving the camera unused for a long period of time will allow mold to grow and result in malfunction. To prevent this, insert a battery (batteries) once a month and release the shutter a few times.

■ Handling the Batteries



WARNING



Keep batteries out of the reach of children.

If a battery is swallowed, immediately contact a physician.

- **Use the following battery (batteries):**

- ① One 3V lithium battery (CR-1/3N type)
 - ② Two 1.55V silver-oxide batteries (SR44 type)
 - ③ Two 1.5V alkaline batteries (LR44 type)
- Before important photographic occasions, check and replace the battery (batteries) well before exhaustion, or have spare batteries handy.

- **Turn the power to the camera off when replacing battery (batteries).**

When changing the battery (batteries), fold the film-advance lever and insert the new battery (new batteries) with the + and – ends positioned correctly.

- The supplied battery is for checking the operation of the camera at the time of purchase. It may have a shorter life than a new one.
- Stains on the battery poles may cause lack of contact. Wipe the batteries with a dry cloth before inserting.

- **Use a fresh battery (batteries) when using the camera in very cold temperature.**

The camera may not operate with exhausted batteries.

It is recommended to carry spare batteries, and keep them warm for alternate use.

- The number of film rolls that can be shot decreases in very cold temperatures. However, battery power may recover when the temperature returns to normal.

- **Do NOT throw batteries into a fire.**

Do NOT throw batteries into a fire, short-circuit, disassemble, heat or charge batteries.

A **AE lock**

A function to temporarily store the exposure setting determined by the camera in memory. After measuring the light on a specific portion of the subject (face, etc.) or another object, you can change the angle as desired, maintaining the exposure setting (AE lock is activated with the AE button). When the subject is back lit, first direct the camera to a dark area or fill the frame with the subject for AE lock, then return the camera to the desired angle and framing to shoot.

Aperture-priority auto exposure

An automatic mechanism to obtain the proper exposure by automatically controlling the shutter speed depending on the aperture specified by the operator. This mechanism provides flexible photographing, such as focusing on the foreground subject and having an out-of-focus background with a wide aperture opening, or to keep the overall picture in clear focus with a small aperture opening.

B **Blank exposure**

With a camera with manual film winding, initial film advancing is required by repeatedly releasing the shutter and winding the film until the film counter indicates the first frame.

C **Cable release**

A shutter release device designed to eliminate vibration caused by slight movement of the camera from pressing the shutter button with the camera on a tripod.

Center-weighted metering

Light is measured with priority given to the center of the image, gradually decreasing the metering level towards the edges.

Correct exposure

The exposure setting for the film that best reproduces the lighting condition of the subject, from its highlights to shadowed portions. Or, the setting that can best provide an image that matches the intention of the photographer. While the best combination of shutter speed and aperture value for the sensitivity of film in use may normally provide the correct exposure, this may not be true for the specific result you are looking for.

D **DX code**

The bar code on a cartridge of 35mm film. The bar code contains information on the type of film, sensitivity, and number of frames. A camera that can read DX code is automatically adjusted by reading the information.

E

EV

EV stands for Exposure Value, which indicates the exposure settings. For example: using ISO 100 film with a shutter speed of one second and an aperture setting of $f/1.0$, the EV is defined as 0 (EV 0). This value increases by one each time the aperture is stopped down or the shutter speed is increased by one unit. The aperture and shutter speed are indicated in the built-in exposure meter of the camera as values converted from the EV.

Exposure

Exposing the film to light with a combination of the aperture and shutter speed settings. The aperture is used to adjust the amount of light that reaches the film, and the shutter speed is used to adjust the length of time the film is exposed, thus providing the correct exposure.

Exposure compensation

To change the standard exposure determined by an exposure-meter. By intentionally changing the exposure setting, you may obtain a desired effect. Increasing the exposure is called positive compensation, and decreasing it is called negative compensation. Exposure compensation may be effective when the luminance, reflection, position, or size of the subject may cause an exposure error.

F

Flash-exposure compensation

The light-control system that automatically controls the illumination level of the flash according to the ambient brightness is called flash exposure. Flash-exposure compensation is a function to increase/decrease this automatic-level-control range.

Flash-shooting distance range

The range in which the proper exposure can be obtained in flash photography. The higher the film sensitivity, the wider the range, and vice versa. The wider the lens aperture, the wider the range, and vice versa. Pictures must be taken within the flash shooting distance range.

Full aperture

The minimum aperture value (smallest f-number) for a lens is "full aperture." With the full aperture opening, the depth of field is shallow, and images are defocused more in the background while widening the shootable range for the amount of light.

F Full-aperture metering

One of the light-metering systems of a camera with a built-in TTL exposure meter. After you make the aperture setting, the camera determines the correct shutter speed by measuring the light with full aperture. As the aperture is kept fully open, the view in the viewfinder is bright, enabling easy focusing. The lens will then be stopped down to your aperture setting when you release the shutter. On the contrary, metering the light with the actual aperture setting for shooting is called "stop-down metering." This may darken the view in the viewfinder making focusing difficult. With some special lenses or certain accessories (such as a bellows attachment), only stop-down metering is available.

G Guide number

Used as a standard value to numerically show the illumination level (ISO 100, m, 20°C / 68°F) of flash. The value is indicated in units of GN (ISO 100, m). An aperture setting value for the correct exposure can be obtained by the following equation. Aperture value (f) = Guide number (GN) / Shooting distance (meters).

I ISO film speed

A unit to indicate the film sensitivity, defined by the ISO (International Organization for Standardization).

M Manual exposure

Shooting is performed by manually setting the shutter speed and aperture value based on the light level measured by an external or built-in exposure meter. With manual exposure, shooting can be performed independent from changes in conditions. You may want to make a solemn image by setting the exposure to a low level, or add a cheerful atmosphere by setting it to a high level.

Mechanical shutter

A shutter system that mechanically controls the shutter speed. Its advantage is that no power is required, permitting you to shoot even when the battery power is exhausted. This may be especially effective for photographing with long-time exposure or at low temperatures at which batteries would have to be warmed.

Multiple-exposure photography

To expose a single frame more than once.

N ND filter

ND stands for Neutral Density. ND filters can flatly decrease the light level without masking out any specific wavelength (color).

O Overexposure

A state in which the total exposure is too great when compared with standard exposure.

T

TTL

An abbreviation of "Through the Lens," which represents a system to determine the brightness of the subject by metering the light through the lens with the built-in exposure meter of the camera.

TTL flash

A function to obtain the correct exposure for the main subject by firing the flash regardless of the ambient light. By measuring the amount of the flash light reflected from the subject, the camera stops light emission when the correct illumination level is reached. This may possibly cause an imbalance in brightness between the main subject and the background.

U

Underexposure

A state in which the total exposure is insufficient when compared with standard exposure.

Specifications

Type of camera

35mm single-lens reflex with electronically and mechanically controlled focal-plane shutter

Applicable film

35mm film in a cartridge

Frame size

24 × 36mm

Lens mount

Nikon F mount

Shutter

Vertical-travel, metal focal-plane shutter

Shutter-speed settings

A (aperture-priority auto): 8 to 1/4000 sec., electronic stepless control (indications are 1 to 1/4000) Manual: Bulb, 1 to 1/4000 sec., mechanical control

Viewfinder

Eye-level pentaprism

Eyepoint

14mm (at -1.0 m⁻¹)

Focusing screen

K3 type (splitprism-image micropism type, Clear Matte Screen IIa) standard, B3 type and E3 type optional

Viewfinder frame coverage

Approx. 93% (objective screen)

Viewfinder magnification

0.83x with 50mm lens set to infinity

Viewfinder information

Shutter speed, exposure meter indication, shutter indication, direct aperture value, exposure compensation mark, ready light

Reflex mirror

Quick-return type

Exposure meter sync

Ai type (automatic compensation at full-aperture f-stop)

Metering system

TTL center-weighted, full-aperture exposure metering system, approx. 60% of the meter's sensitivity concentrated on a 12mm diameter circle

Metering range

EV1 to EV20 at ISO100 (with a 50mm f/1.4 lens)

Film-sensitivity settings

DX system or manual. DX: ISO 25 to 5000 Manual: ISO 12 to 6400

Exposure compensation

Exposure compensated to ±2 EV in units of 1/3 EV (compensation to the + side not possible with ISO 12, and that to the - side not possible with ISO 6400)

Auto exposure lock

Enabled by pressing the AE lock button

Film advance

Lever provided, 30-degree standoff angle and 135-degree winding angle, automatic film advance enabled with MD-12 Motor Drive (sold separately)

Frame counter

Additive type (S, 1 to 36), automatic reset

Film rewinding

Film rewind button and crank

Self-timer

Mechanical controlled, countdown time of approx. 4 to 10 seconds, cancellation possible

Depth of field preview

Can stop down lens aperture by pressing the depth of field lever

Multiple exposure

Activated with multiple exposure lever

Sync contact

X-contact only; synchronized with the flash at a low speed of under 1/250 sec.

Flash control

TTL flash: Enabled by using SB-28, SB-27, etc. in combination

TTL flash compensation: Compensation to -1 EV activated with the TTL flash compensation button on the camera

Film speed synchronization in TTL flash: ISO 12 to 1000

Sync terminal

Equipped with sync terminal (ISO 519), locking screw type

Accessory shoe

Hot-shoe contact (ISO 518, sync contact, ready-light contact, monitor contact, stop-signal contact for TTL flash) with a lock hole to prevent accidental dropping

Ready light

Lights when the flash is fully charged with SB-28, SB-27, etc.; blinks for full-output warning or shutter-speed settings from 1/500 to 1/4000 sec.

Camera back

Detachable hinged back; MF-16 Data Back can be attached in place.

Camera-back opening

Achieved with the film-rewind lever

Power source

One 3V lithium battery (CR-1/3N type), two 1.55V silver-oxide batteries (SR44 type), or two 1.5V alkaline batteries (LR44 type)

Meter-on timer

To turn the camera on when the shutter-release button is pressed lightly, turning it off 16 seconds after your finger leaves the button. With the MD-12 Motor Drive, the camera is turned on when the shutter release button of the MD-12 is pressed lightly, and it turns off approx. 66 seconds after your finger leaves the button.

Battery power check

Displayed for 16 seconds with the meter-on timer. The exposure meter does not work if the batteries are exhausted.

Number of film rolls that can be shot

When repeating the procedure of holding the shutter-release button in the lightly-pressed position for 10 seconds, pressing it all the way, and waiting until the meter-on timer counts up to the end, with 36-frame film rolls, a shutter speed of 1/250 second in Aperture-Priority Auto mode:

Power Temperature	One 3V lithium battery	Two 1.55V silver-oxide batteries	Two 1.5V alkaline batteries
At normal temperature (20°C)	approx. 100 rolls	approx. 100 rolls	approx. 45 rolls
At low temperature (-10°C)	approx. 50 rolls	approx. 50 rolls	approx. 10 rolls

Optional exclusive or common accessories

MD-12 Motor Drive
SB-27 Speedlight and equivalents
MF-16 Data Back
CF-27S / CF-28S / CF-29S Camera Case
AR-3 Cable release
etc.

Tripod socket

1/4 (ISO 1222)

Dimensions (W × H × D)

Approx. 142.5 × 90 × 58mm / 5.6 × 3.5 × 2.3 in.
(camera body only)

Weight

Approx. 570g / 20.1 oz. (camera body only, including battery)

- All specifications are calculated assuming fresh batteries are used at normal temperature (20°C / 68°F).
- Specifications and design are subject to change without notice.

No reproduction in any form of this manual, in whole or in part (except for brief quotation in critical articles or reviews), may be made without written authorization from NIKON CORPORATION.

Nikon

NIKON CORPORATION

FUJI BLDG., 2-3, MARUNOUCHI 3-CHOME,
CHIYODA-KU, TOKYO 100-8331, JAPAN

Printed in Japan Y3A00500401 (S954) 11