

***Nikon***

**N200**

**INSTRUCTION MANUAL**

**Film speed ring (lift and turn)/Exposure compensation dial (push lock release button and turn)**



Exposure compensation settings (+2 to -2)

ISO film speed scale (DX setting for DX-coded film; 12 to 3200 for non-DX-coded film)

**Exposure compensation dial lock release button**

**Film rewind crank (fold out to rewind film)**



**Film cartridge window**

**Film plane indicator (exact distance from lens mounting flange and film plane is 46.5mm)**

**Red indicator lamp (blinks (1) when using non-DX-coded film with film speed scale set at DX, (2) when DX contacts require cleaning, (3) at end of film, (4) when shutter is released)**

**Film advance mode selector (lift and turn)/Fingerguard**

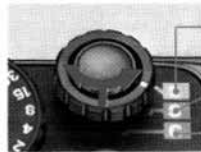

**L** to lock shutter release, turn power off

**S** for single-frame shooting

**C** for continuous shooting

**Shutter release button (to activate exposure meter, lightly press to fingerguard position; to release shutter, depress fully)**

**Camera strap eyelet**

**Frame counter window**

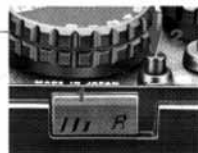

**Film rewind button (press while sliding lever)**

**Film rewind lever (slide to right)**

**Film advance indicator (rotates to show film is loaded and being advanced)**

**Accessory shoe (for electronic flash; see page 26)**

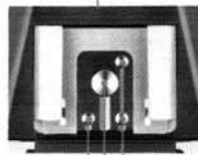

Electrical contacts

**Eyepiece cover** (attaches to viewfinder eyepiece to keep out stray light during self-timer and remote control operation)



**Viewfinder eyepiece**

**Film rewind fork**

**DX contacts** (for automatic film speed setting with DX-coded film; do not touch; keep clean)

**Film cartridge chamber**

**Battery holder screw**



**Tripod socket** (accepts optional Nikon Tripod Adapter AH-3)

**Shutter curtains** (do not touch)

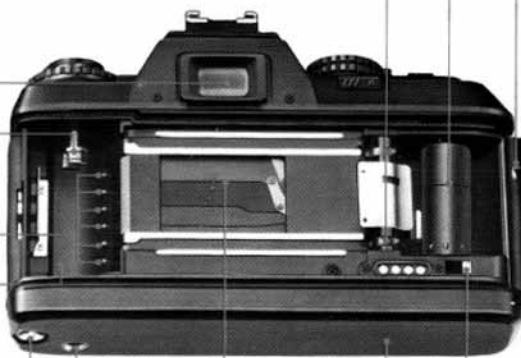

**Film sprocket**

**Film takeup spool**

**Camera back hinge release**  
(push down to remove camera back)

**Film pressure plate**  
(do not touch)

**Camera back** (interchangeable with Nikon Multi Data Back MF-19)



**Film leader index**

**AAA Battery holder MB-4** (remove to change batteries; interchangeable with AA Battery Holder MB-3 to allow use of AA-type batteries)

## **FOREWORD**

Thank you for your kind patronage of Nikon. We hope the N2000 will make photography a much bigger part of your life.

Get to know your N2000, but before using it, be sure to read this manual well.

# BASIC OPERATION

## MOUNTING THE LENS



**1.** Mount lens.

To remove

For unusable lenses, turn to  
page 36.

## INSTALLING BATTERIES AND CHECKING POWER



- 2.** Remove AAA battery holder MB-4.

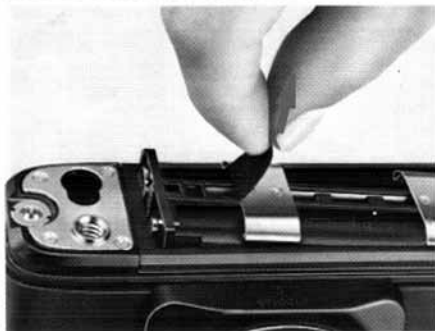

- 3.** Remove bracket.

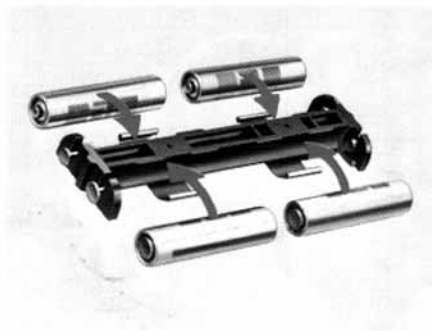

- 4.** Install four AAA-type batteries.

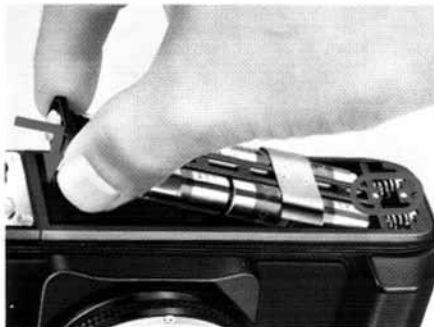

- 5.** Align the white dots and put back bracket.



- 6.** Reattach battery holder.

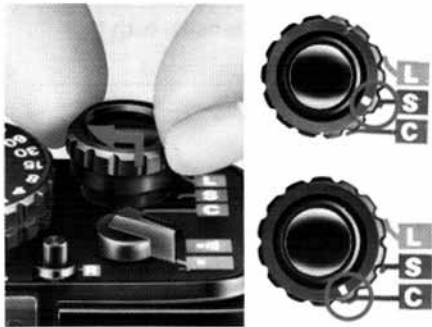

- 7.** Set film advance mode selector.



**8. Lightly press shutter release button to finger-guard position and check battery power by LED inside viewfinder.**

LED lights up if power is sufficient, and stays on for 16 sec. after you take your finger off the button, unless you release the shutter. When you release the shutter, the LED turns off a second after you remove your finger from the button.

**For battery check, the shooting mode dial may be set at any position except B.**

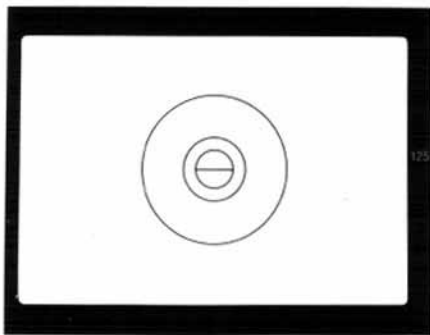

125

**Lit-up LED**  
Battery power is sufficient.



If LED goes off immediately after finger is removed from the button, batteries are almost dead.

**No LED**  
Dead batteries or improper battery installation

## LOADING FILM

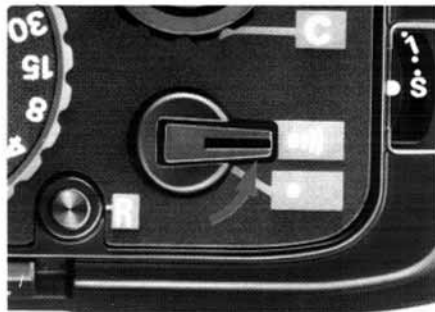
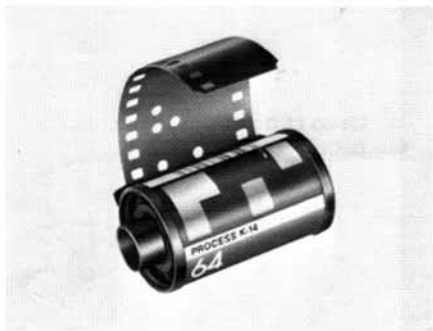

- 9.** With DX-coded film, set film speed index at DX.  
Usable film speed range for DX-coded film is ISO 25 to 4000.

- 10.** Set audible warning switch to  position



With non-DX-coded film, set to the appropriate film speed.

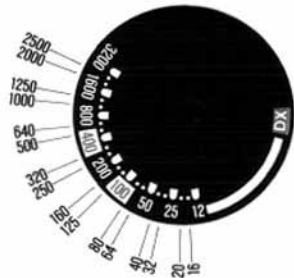

The two dots between numbers stand for intermediate settings.





**11. Open camera back.**

Pull up film rewind knob until back springs open.

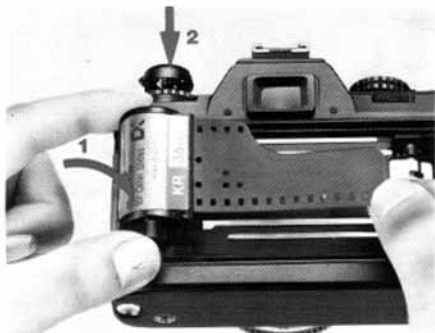

**12. Position film cartridge.**

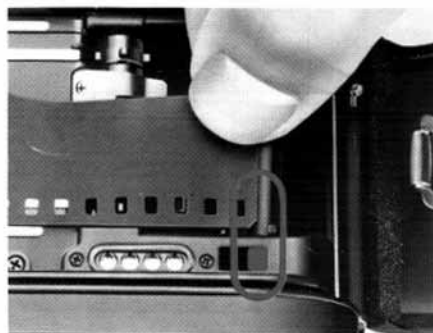

**13. Pull film leader out to red index mark.**



Avoid loading or unloading film in direct sunlight.

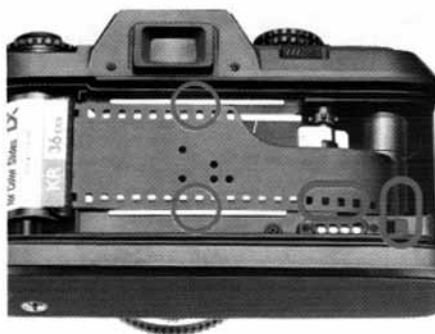

- 14.** Check film position and close camera back.

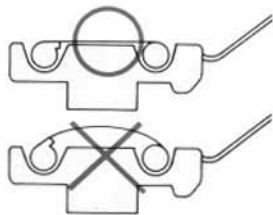

There should be no film slack.



- 15.** Depress shutter release button to automatically advance film to frame "1".

Film advance indicator rotates to show proper film installation.

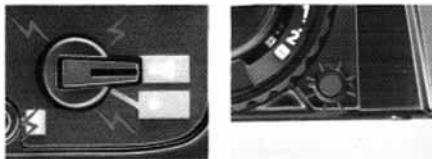
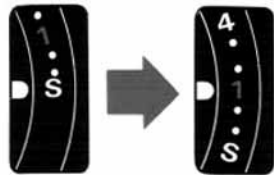

If audible warning beeps and red indicator lamp blinks, check the following:  
(1) Make sure you are using DX-coded film.  
(2) Make sure DX contacts are clean. (See page 30.)

## SHOOTING IN P MODE

The Nikon N2000 lets you choose four exposure modes, the Dual Program modes (P and P HI) and Aperture-Priority (A), plus Manual (M). Of the four modes, P mode is the easiest to use for most photography. For details, refer to pages 19 to 22.

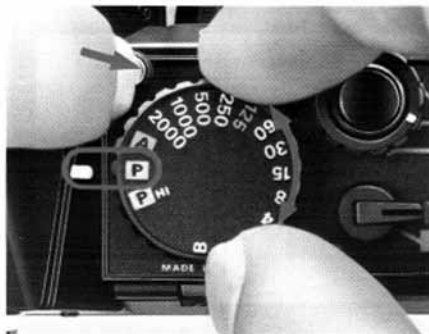

### 16. Set shooting mode selector dial to P.

Turn the dial while pressing the lock button.



### 17. Set lens to its minimum aperture (largest f/number).

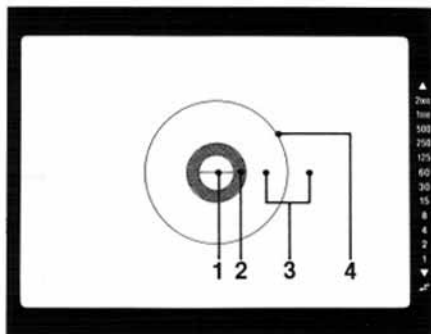

1. Split-image rangefinder
2. Microprism color
3. Matte field
4. 12mm-dia. central area

Correct exposure is assured when main subject is placed in this area.

## 18. Compose and focus.

### (A) Split-image focusing

For precise, pinpoint focusing of subjects with distinct contours, turn the focusing ring until the split-image becomes whole.

### (B) Microprism focusing

For rapid focusing and for subjects with indistinct outlines, turn the focusing ring until the shimmering image becomes sharp.

### (C) Matte field focusing

For close-up photography at high magnification, or when using a telephoto lens with a maximum aperture of approx.  $f/11$  or smaller, the split-image may darken. Turn the focusing ring until the image on the matte field appears sharp.

**(A) Split-image  
focusing**

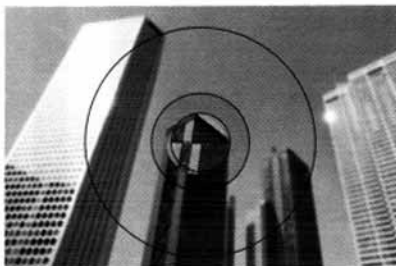

Out of focus

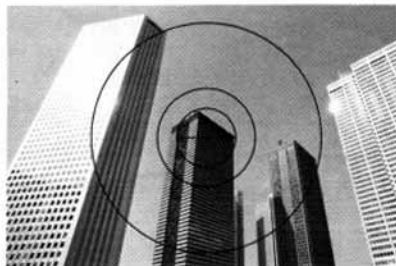

In focus

**(B) Microprism  
focusing**



Out of focus



In focus

**(C) Matte field  
focusing**



Out of focus

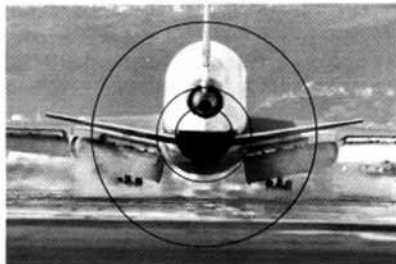

In focus

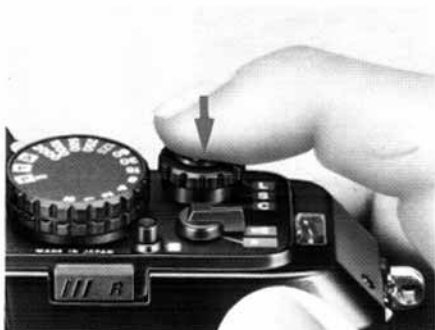

Correct exposure is assured.



Two LEDs show intermediate shutter speed.

## 19. Lightly press shutter release button.

If there is no warning beep, you can take the picture.

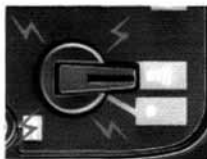

If there is a warning beep, check the viewfinder LED indicators for the following:

**(1) Picture blur possibility (1/30 sec. or slower)**

Use a tripod to avoid camera shake, or use a flash to synchronize the shutter speed at 1/125 sec.



**(2) Top LED triangle blinks — overexposure warning**

Use a neutral density (ND) filter.



**(3) Bottom LED triangle blinks — underexposure warning**

Use electronic flash.

**Both top and bottom LED triangle blinks — wrong-aperture-set warning**



Set lens to minimum aperture. With an AI-modified Nikkor lens\*, teleconverter, or PK ring, there is no warning.

\*See page 36.



**20.** Depress shutter release button to take picture.



At S, depressing and releasing the shutter release button *automatically* advances the film by one frame.



At C, shots are continuously taken at up to 2.5 frames per second (fps) as long as the shutter release button is depressed.

When finger is removed from the shutter release button, the exposure meter and viewfinder LEDs stay on for a second—then automatically turn off. To activate the meter for the next shot, press the shutter release button again—lightly—and it will remain on for 16 sec.

## REWINDING FILM



**21.** Film winding stops automatically at end of film.

When the shutter release button is depressed, there is a bleep and the red indicator lamp blinks to tell you to rewind film.



**22.** Set the film advance mode selector to L.



**23.** While sliding film rewind lever, push film rewind button.



**24.** Rewind film.  
Fold out film rewind crank and rotate until the film advance indicator stops moving.

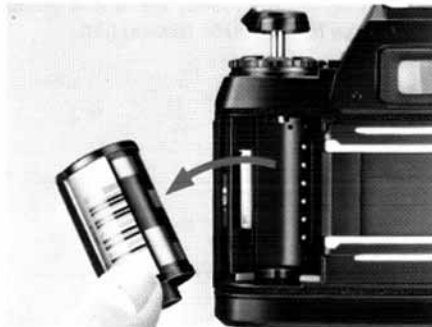

**25.** Remove film cartridge.





# EXPOSURE

## PROGRAMMED EXPOSURE MODES

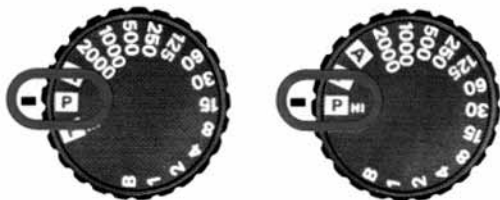

The N2000's microcomputer automatically sets the optimum combination of shutter speed and lens aperture. Dual Program lets you select two programmed automatic modes—normal (P) and high-speed (P HI). If you require a high shutter speed, such as when using a telephoto lens or for shooting a fast-moving subject, select P HI. (See pages 13 to 17 for operation of programmed automatic exposure.)

Dual program chart (50mm f/1.4, ISO 100)

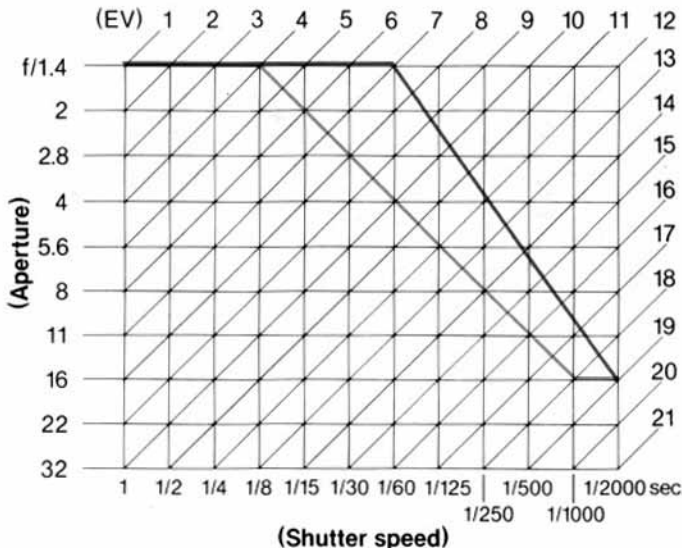

This EV (exposure value) chart demonstrates the difference between the N2000's Normal and High-Speed Programs. Just look where either colored line intersects with a diagonal line. This shows the combination of aperture (horizontal line) and shutter speed (vertical line). For example, at a brightness of EV 12, the N2000 selects f/4 and 1/250 sec. at "P HI"; f/5.6 and 1/125 sec. at "P" (with 50mm f/1.4 lens at ISO 100).

## APERTURE-PRIORITY EXPOSURE MODE

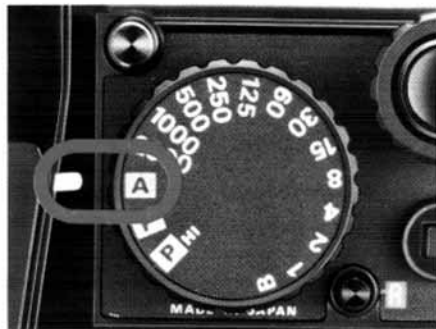

Correct exposure is assured.



Two LEDs show intermediate shutter speed.

At A, the N2000's microcomputer automatically selects the correct shutter speed to match the aperture you set. This is the recommended mode when depth of field is your prime consideration. If you want to blur the background in portraits, for instance, use wide apertures. To make everything come out sharp in scenic photography, use small apertures.

1. Set shooting mode selector to A.
2. Set lens to desired f-number (engraved on aperture scale)
3. Look inside viewfinder and lightly press shutter release button.

The LED shows the shutter speed selected by the camera for correct exposure with the aperture you set. If there is no warning beep, you can take the picture by depressing the shutter release button.



**(1) Picture blur possibility  
(1/30 sec. or slower)**

Use a tripod to avoid camera shake, or use a flash to synchronize the shutter speed at 1/125 sec.



**(2) Top LED triangle blinks—  
overexposure warning**

Stop the lens down until the LED stops blinking, or use a neutral density (ND) filter.



**(3) Bottom LED triangle blinks—  
underexposure warning**

Select a wider aperture or, if necessary, use a flash.

## MANUAL EXPOSURE MODE

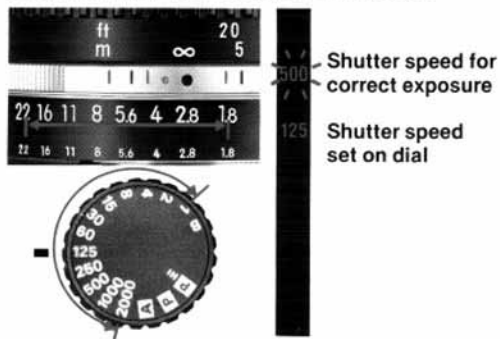

Adjust shutter speed and/or aperture

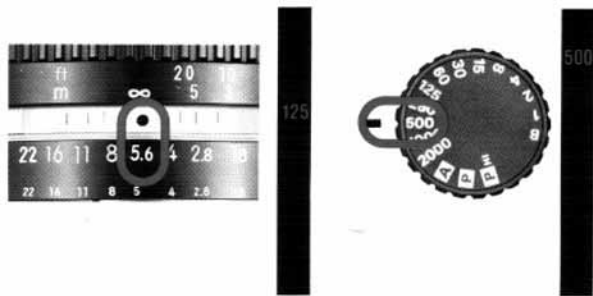

In the M mode (1—1/2000 sec.), both shutter speed and aperture can be set manually according to the effect desired. Use fast shutter speeds to stop action, slower speeds to produce a deliberate blur. Manual mode also allows control of depth of field.

1. Set shutter speed and aperture.
2. Look inside viewfinder and press shutter release button lightly.

Non-blinking LED shows shutter speed set on the dial; a blinking LED indicates the shutter speed for correct exposure. With two blinking LEDs, the correct shutter speed is intermediate. Reset aperture and/or shutter speed so only one LED is shown.

There is no audible warning in M mode.

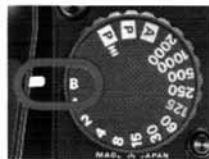

At B setting, shutter curtains remain open as long as the shutter release button is depressed. Although no LED appears inside the viewfinder, the camera meter is on at B.

## FOR SPECIAL EXPOSURE SITUATIONS

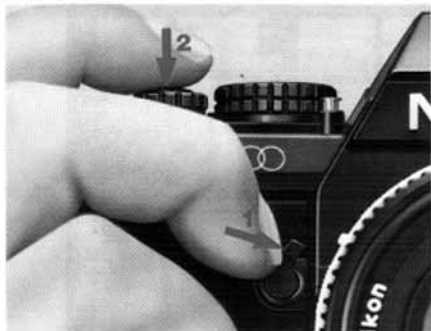

### Auto exposure lock lever

In P, P HI and A modes, to shoot a subject outside the 12 mm-dia. circle, or when there is a substantial difference in brightness between the main subject and the background (e.g., a strongly backlit subject), use the auto exposure lock lever. Holding the lever in locks the correct exposure value on the principal subject of your picture.

1. Center principal subject inside the viewfinder or move in closer to the subject.
2. Lightly press shutter release button.
3. Turn auto exposure lock lever towards lens and hold it in.
4. Recompose and shoot.

When you recompose, in A mode, the LED that indicates the shutter speed for the central 12mm-dia. circle area blinks. (See example at right). Ignore the blinking LED. The shutter operates at the speed indicated by the lit-up LED (1/60 sec. in the example). In P and P HI modes, only the lit-up LED is shown.



(In A mode)



60 = Shutter speed  
for the girl's face

250 = Shutter speed  
for the background



### Suggested applications for exposure compensation

- +2 White background, snow scene
- +1 White background occupying half of viewed area
- 1 Spotlit subject, black background occupying half of viewed area
- 2 Black background



250

### Exposure compensation dial

For unusual lighting situations—snowscapes, backlit subjects, or when the main subject contrasts sharply with the background—use the exposure compensation dial to prevent over- or underexposure. -1 and -2 indicate one and two stops less exposure; +1 and +2 indicate one and two stops additional exposure. With film speed set at ISO 1600, compensation extends to -1; at ISO 3200, you can rotate the dial only in the + direction. To operate, press the lock button and set the desired compensation value. After use, reset the dial to 0.

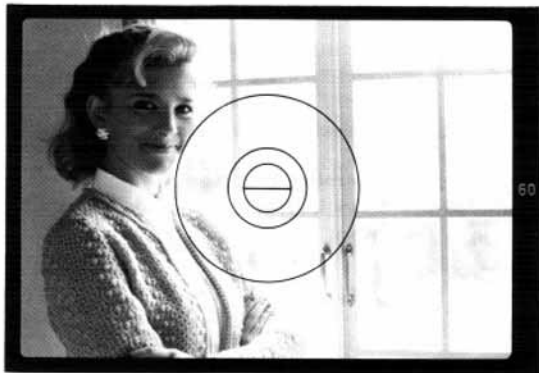

60

## SELF-TIMER

---

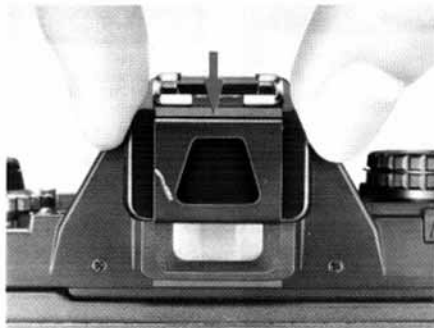
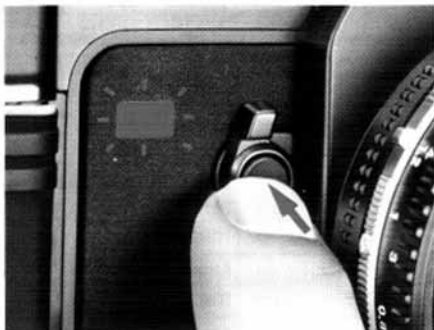

Press the self-timer button. The self-timer lamp blinks and a bleep sounds (if the audible warning switch is set at  position) for 10 sec. before the shutter is released. During the final two seconds, the warnings speed up, telling you to get ready. If you want to cancel the self-timer after activating it, press the button a second time.

In the P, P HI or A mode, use the eyepiece cover to prevent stray light from entering the viewfinder.

Regardless of the film advance mode selector setting, only single-frame shooting is possible.

# FLASH PHOTOGRAPHY



The N2000 accessory shoe allows direct mounting of Nikon dedicated electronic flash units.

When the N2000 is set at A, P, P HI, or a manual setting of 1/250 sec. or higher, shutter speed automatically switches to 1/125 sec. for proper flash synchronization. When the N2000 is set at a manual setting of 1/125 sec. or slower, shutter operates at the speed set on the dial.

Ready-light indication in the viewfinder is also provided with Nikon dedicated flash units. With the camera's meter on, a thunderbolt-mark LED ready-light comes on to indicate the flash is ready to fire. Warning indications are provided by a blinking ready-light. Conditions represented by the warning vary between flash unit models. For details, see your flash unit instruction manual.

Use Nikon Speedlights only. Other units may damage the camera's electrical circuit.

Nikon Speedlight	Connection	Usable Flash Mode
SB-15/SB-16B/ SB-18	Direct	programmed TTL auto*, TTL auto, non-TTL auto, manual
SB-11/SB-14	Via TTL Remote Cord SC-23	Programmed TTL auto*, TTL auto, manual
	Via Sensor Remote Cord SC-13	Non-TTL auto, manual
SB-16A/SB-17	Via Flash Unit Coupler AS-6	Non-TTL auto, manual

\* Programmed TTL auto flash photography can only be performed with **AI-S type Nikkor and Nikon Series E** lenses. For information on how to recognize **AI-S type** lenses refer to page 36.

*The following instructions are for programmed TTL auto and TTL auto flash shooting only. For non-TTL auto and manual flash shooting, see your flash unit instruction manual.*

Note that the film speed range for programmed TTL auto and TTL auto flash photography is ISO 25 to 1000.



## PROGRAMMED TTL AUTO FLASH PHOTOGRAPHY IN P AND P HI MODES



### Viewfinder indication



Flash sync speed—  
shutter operates  
at 1/125 sec.



### Warning indication

If triangle-shaped top and bottom LEDs blink, check your lens type (must be an AI-S type), or reset lens to minimum aperture.

In programmed TTL auto flash photography, the camera selects the appropriate aperture. Note that only **AI-S type** lenses can be used.

Set the N2000 to P or P HI, and set lens to minimum aperture (largest f-number). Set the flash unit's mode selector to TTL, and turn the flash unit on. Look inside the viewfinder and lightly press the shutter release button. With the ready-light on, as long as you have none of the following warning indications, you can shoot.

## TTL AUTO FLASH PHOTOGRAPHY



### Viewfinder indication

**At A, or Manual setting of 1/250 sec. or faster**

Flash sync speed—shutter operates at 1/125 sec.

Proper shutter speed for shooting without flash unit

**At Manual setting of 1/125 sec. or slower**

Shutter speed set on the shooting mode selector dial—shutter operates at 1/125 sec. to 1 sec., as selected.

Proper shutter speed for shooting without flash unit.

In TTL auto flash photography, select appropriate aperture.

Set the N2000 to A or one of the Manual settings. Determine aperture using the flash unit exposure calculator dial. (Refer to flash unit instruction manual for details.) Set the flash unit mode selector to TTL and turn the flash unit on. Look inside the viewfinder and lightly press the shutter release button. When the ready-light comes on, you can shoot.

## INFRARED PHOTOGRAPHY

### VIEWFINDER READY-LIGHT WARNINGS



In both programmed TTL auto and TTL auto flash photography, the viewfinder ready-light blinks to warn of improper film selection, poor connection between camera and flash unit, or underexposure possibility. To prevent the viewfinder ready-light from blinking:

- 1) Use film with ISO range of ISO 25 to 1000.
- 2) Keep flash unit and camera electrical connections clean.
- 3) Make sure the subject is within the **automatic shooting range\*** and, if necessary, set lens to wider aperture.

\*See your flash unit instruction manual.

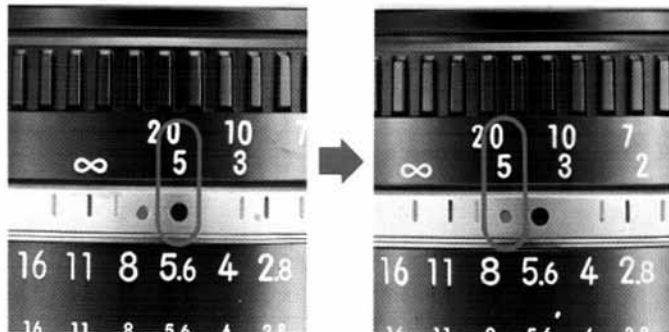

An appropriate filter is needed for infrared photography, such as R60, etc.

1. Focus subject.
2. Note the focused distance on the lens that is aligned with the distance index.
3. Then reset the focusing ring to align the focused distance with the infrared focusing index.
4. Attach filter and take the shot.

## CAMERA CARE TIPS



1. Never touch the reflex mirror or focusing screen. Remove dust with a blower brush.

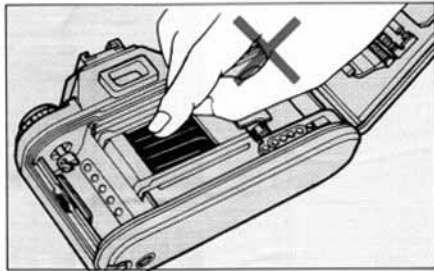

2. Never touch the shutter curtains.

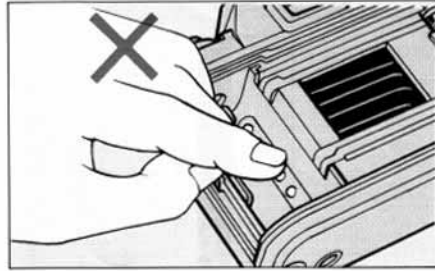

3. Never touch the DX-contacts. Keep clean with blower brush.

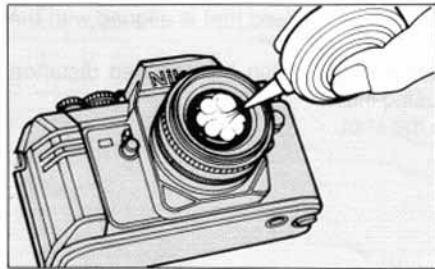

7. Clean glass surfaces such as the lens or the viewfinder eyepiece with blower brush; avoid using lens tissue as much as possible. Wipe dirt and smudges, using soft cotton moistened with pure alcohol, in a spiral motion from center

to periphery. Be careful not to leave traces.

### Caution

A spray gun-type blower may damage the glass (especially when ED glass is used for the front lens element) if used to clean the lens. To avoid damage, hold blower upright with the nozzle more than 30cm (12 in.) away from the lens surface, and keep the nozzle moving so the stream of air is not concentrated in one spot.

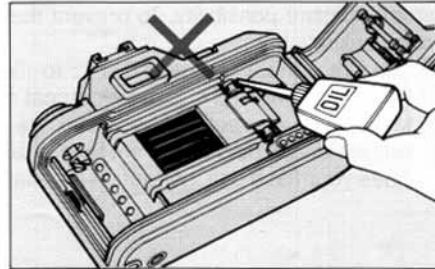

8. Do not lubricate the camera.

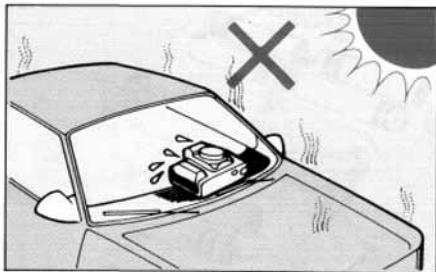

4. Do not leave your camera in an excessively hot place.

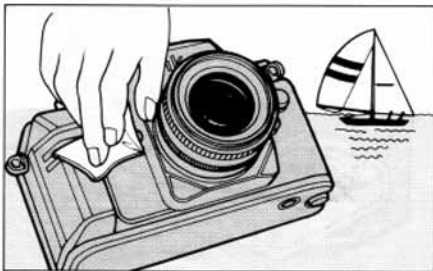

5. If the camera is exposed to rain or mist, or after shooting near the sea, wipe with a clean, soft cloth.



6. If the camera malfunctions, take it immediately to an authorized Nikon dealer or service center.

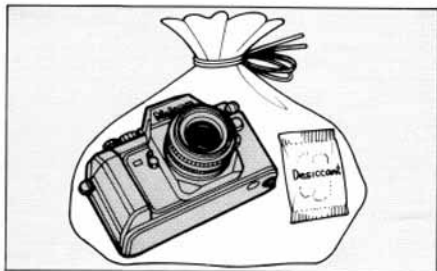

9. Store the camera in a cool, dry place away from naphthalene or camphor (moth repellents).  
In humid environments, store camera inside a vinyl bag with a desiccant to keep out dust, moisture and salt.



Note, however, that storing the leather case in a vinyl bag may cause the leather to deteriorate.

# ABOUT BATTERIES

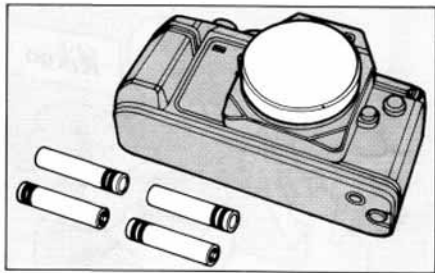

1. When not using the camera for a long period, remove batteries.



2. Battery power falls off in extremely cold temperatures—if you want to use the camera, use new batteries and wrap the camera body in something warm.

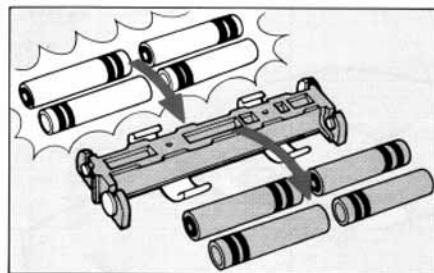

3. When replacing batteries, replace both at the same time. Always use fresh batteries of the same brand.

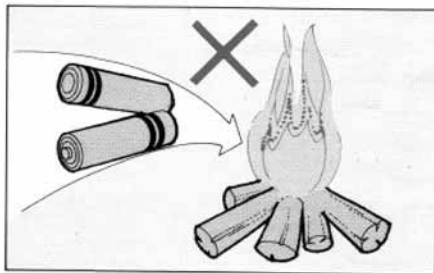

4. Never throw used batteries into a fire.



5. If the battery chamber is contaminated by battery leakage, take the camera to a Nikon dealer.

# SPECIFICATIONS

<b>Type of camera</b>	Integral-motor 35mm single-lens reflex		
<b>Picture format</b>	24mm x 36mm (standard 35mm film format)		
<b>Lens mount</b>	Nikon bayonet mount		
<b>Lenses</b>	More than 70 Nikkor and Nikon Series E lenses available		
<b>Exposure metering</b>	Light intensity feed back measurement (P, P HI, A), TTL full-aperture center-weighted exposure measurement (M); employs one silicon photo diode (SPD)		
<b>Exposure meter switch</b>	Meter turns on when film advance mode selector is set at S or C and shutter release button is pressed lightly; stays on for approx. 16 sec. after lifting finger from button		
<b>Metering range</b>	EV1 to EV19 at ISO 100 with f/1.4 lens		
<b>Exposure control</b>	Dual Program (normal and high-speed) and A (aperture-priority) auto exposure modes, and M (manual) exposure mode Choice of normal or high-speed program; both shutter speed and aperture are set automatically		
<b>Dual Program mode exposure control</b>	Shutter speed automatically set to match manually set aperture		
<b>A (aperture-priority) mode exposure control</b>			
<b>M (manual) mode exposure control</b>	Both aperture and shutter speed are set manually		
<b>Shutter</b>	Electronically controlled vertical-travel focal-plane shutter		
<b>Shutter speeds</b>	Stepless speeds from 1 to 1/2000 sec. on P, P HI and A auto exposure modes; lithium niobate oscillator-controlled discrete speeds from 1 to 1/2000 sec. on		
		<b>Viewfinder</b>	manual; electronically controlled long exposure at B (bulb) setting Fixed eyelevel pentaprism type; 0.85X magnification with 50mm lens set at infinity; approx. 92% frame coverage
		<b>Eyepiece cover</b>	Prevents stray light from entering viewfinder
		<b>Focusing screen</b>	Fixed Nikon Type K2 BriteView screen with central non-shading split-image rangefinder circle, microprism collar and matte/Fresnel outer field; 12mm-dia. reference circle denotes centerweighted metering area
		<b>Viewfinder information</b>	Shutter speed LED; over- and under-exposure warning LEDs; ready-light when used with Nikon dedicated electronic flash <b>P and P HI modes:</b> LED shows shutter speed selected by camera; top or bottom warning LED blinks to indicate over- or underexposure; top and bottom LEDs blink to indicate incorrect aperture setting <b>A mode:</b> LED shows shutter speed automatically selected by camera; top or bottom warning LED blinks to indicate over- or underexposure <b>M mode:</b> Non-blinking LED shows shutter speed set on dial; blinking LED shows shutter speed for correct exposure; two blinking LEDs show intermediate shutter speed; no LED at B (bulb)

<b>Auto exposure lock</b>	Operates in P, P HI and A modes; holding the lever in locks the exposure memory	<b>Audible warning alarm</b>	With switch on, beeps (1) when using non-DX-coded film with film speed scale set at DX, (2) when DX contacts require cleaning, (3) for over- or underexposure and possible picture blur in auto exposure modes, (4) at end of film (5) during self-timer operation
<b>Exposure compensation</b>	$\pm 2$ EV compensation (in one-third increments) possible by using compensation dial	<b>Red indicator lamp</b>	Blinks (1) when using non-DX-coded film with film speed scale set at DX, (2) when DX contacts require cleaning, (3) at end of film, (4) when shutter is released
<b>Film speed range</b>	ISO 25 to 4000 for DX-coded film, ISO 12 to 3200 for non-DX-coded film	<b>Self-timer</b>	Electronically controlled 10 sec. exposure delay; blinking LED and beep sound indicate self-timer operation
<b>Film speed setting</b>	Automatically set to ISO speed of DX-coded film used; with non-DX-coded film, ISO speed is set manually	<b>Reflex mirror</b>	Automatic, instant-return type
<b>Film loading</b>	Film automatically advances to first frame when shutter release button is depressed once; film advance indicator rotates to show that film is loaded and being advanced properly	<b>Camera back</b>	Hinged back with film cartridge confirmation window and film advance indicator; swings open when film rewind knob is pulled up; interchangeable with Nikon Multi Data Back MF-19
<b>Film advance</b>	Film automatically advances to frame "1" after depressing and releasing shutter release button; at S (single-frame), film automatically advances one frame when shutter is released; at C (continuous), shots are continuously taken at 2.5 fps as long as the shutter release button is depressed; stops automatically at end of film	<b>Accessory shoe</b>	Standard ISO-type with hot-shoe contact, ready-light contact, TTL flash contact, monitor contact
<b>Frame counter</b>	Additive type; automatically reset when camera back is opened	<b>Flash synchronization</b>	1/125 sec. or slower with electronic flash; with Nikon dedicated flash unit, automatically set to 1/125 sec. when camera is set at P HI, P, A, or manual setting of 1/250 or higher; at slower manual speed, shutter fires at speed set
<b>Film rewind</b>	Manual		
<b>Remote control</b>	Use Nikon optional Remote Cord MC-12A		



**Flash ready-light** Viewfinder thunderbolt LED lights up when Nikon dedicated flash unit is ready to fire

**Power source** Four 1.5V AAA-type batteries; with optional Nikon AA Battery Holder MB-3, four 1.5V AA-type batteries can be used

**Number of film rolls per set of fresh batteries (approx.)**

Batteries		With 24-exposure film rolls		With 36-exposure film rolls	
		At 25°C (77°F)	At -10°C (14°F)	At 25°C (77°F)	At -10°C (14°F)
AAA-type	Alkaline-manganese (LR03)	90	9	60	6
	NiCd (KR-AAA)	60	30	40	20
	Zinc-carbon (UM-4)	30	3	20	2
AA-type	Alkaline-manganese (LR6)	270	75	180	50
	NiCd (KR-AA)	180	90	120	60
	Zinc-carbon (SUM-3)	90	9	60	6

**Dimensions (W × H × D)** 5.8 × 3.8 × 2 in.;  
148.5 × 97.5 × 51mm

**Weight (body only, without batteries)** Approx. 20.0 oz.;  
approx. 570g

# LENSES

## Lenses not listed below should not be used with the Nikon N2000

All AI-type Nikkor lenses (including AI-S type Nikkor lenses)

All Nikon Series E lenses

Medical-Nikkor 120mm f/4 IF

Reflex-Nikkor 500mm f/8

Reflex-Nikkor 1000mm f/11 (No. 143001 or larger)

Reflex-Nikkor 2000mm f/11 (No. 200311 or larger)

PC-Nikkor 28mm f/3.5

PC-Nikkor 28mm f/4 (No. 180901 or larger)

PC-Nikkor 35mm f/2.8 (No. 851000 or smaller, or No. 906201 or larger)

Zoom-Nikkor 180-600mm f/8 ED (No. 174167 or larger)

Zoom-Nikkor 200-600mm f/9.5 (No. 300491 or larger)

Zoom-Nikkor 360-1200mm f/11 ED (No. 174088 or larger)

For AI-modification of most non-AI Nikkor lenses having both an automatic diaphragm and meter coupling shoe, contact an authorized Nikon dealer. Though AI-modified, the following lenses cannot be used with the Nikon N2000: Nikkor 55mm f/1.2 (No. 184711-400000), Nikkor 28mm f/3.5 (No. 625611-999999) and Nikkor 35mm f/1.4 (No. 385001-400000)

## AI-Type Nikkor Lens

Note meter coupling ridge and meter coupling shoe with two holes.



## AI-S-type Nikon and Nikkor Lens

AI-S type Nikkor lenses are included among AI-type Nikkor lenses. Note lens-type signal notch and orange minimum aperture scale. All Nikon Series E lenses are of the AI-S type.

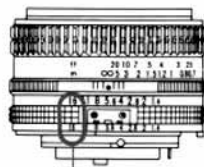

Minimum aperture  
in orange

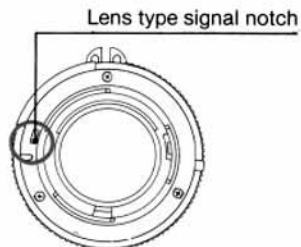

**Note:**

1. *PC-Nikkor and Medical-Nikkor lenses cannot be used in any auto exposure modes.*
2. *The following lenses and accessories do not have an aperture coupling device, and cannot be used in P or P HI modes.*
  - All Reflex-Nikkor lenses*
  - All PC-Nikkor lenses*
  - Bellows attachment*
  - Extension Ring Set K*
3. *In P and P HI modes, when using AI-modified Nikkor lenses with a maximum aperture smaller than f/4.5, or teleconverters or PK rings, shutter speeds are slower than indicated by the standard program lines on page 19. Although actual shutter speed is indicated by the LED and correct exposure is assured even in these cases, always check the LED to avoid blurred images at slower shutter speeds.*
4. *In P and P HI modes, when using AI-modified Nikkor lenses with a maximum aperture larger than f/2, the metering range for higher EV values will be reduced to a maximum of two EVs depending on the aperture.*
5. *In P and P HI modes, the following lenses may cause slower shutter speeds than those indicated by the viewfinder LED, but you still get correct exposure.*
  - Nikkor 50mm f/1.2 (No. 250525 or smaller)*
  - Noct-Nikkor 58mm f/1.2 (No. 175000 or smaller)*
  - Zoom-Nikkor 50-300mm f/4.5 (No. 179500 or smaller)*
  - AI-modified Nikkor 85mm f/1.8*
  - AI-modified Micro-Nikkor 105mm f/4*
  - AI-modified Zoom-Nikkor 85-250mm f/4*

**When using Nikon Teleconverters:** Depending on the lens in use, the shutter speed in A mode may be faster than that indicated in the viewfinder by one step or less, and in M mode exposure compensation may be necessary. For details, see the teleconverter's instruction manual.